

מספר	תאריך	תפוצה
1	14.03.18	
2	20.03.18	
שינוי עדיכון		
מספר	תאריך	

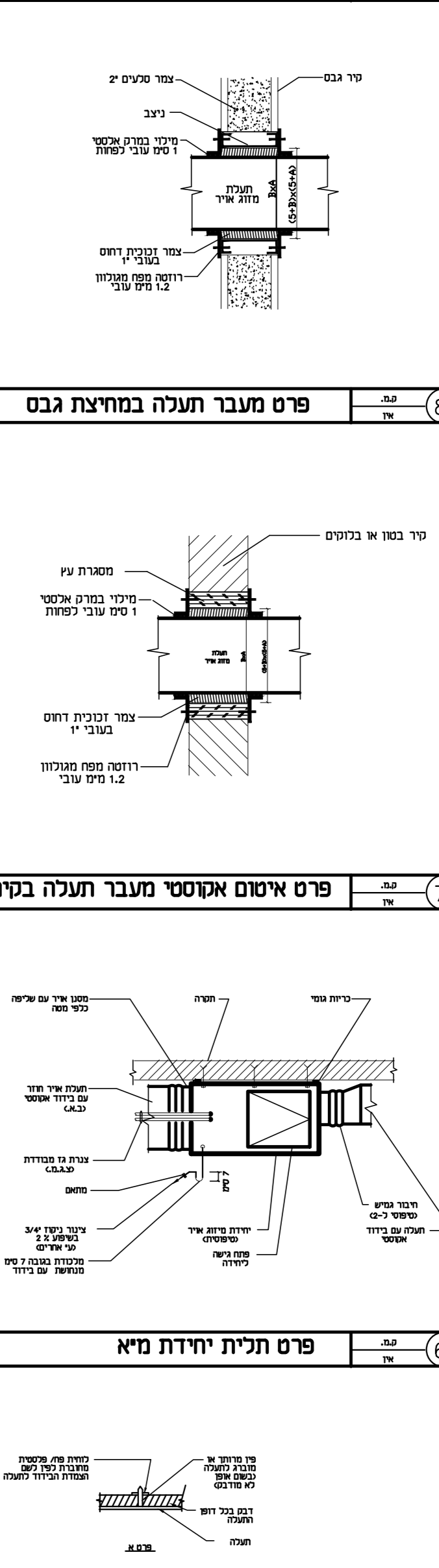

מספר	תאריך	תפוצה
1	14.03.18	
2	20.03.18	
שינוי עדיכון		
מספר	תאריך	

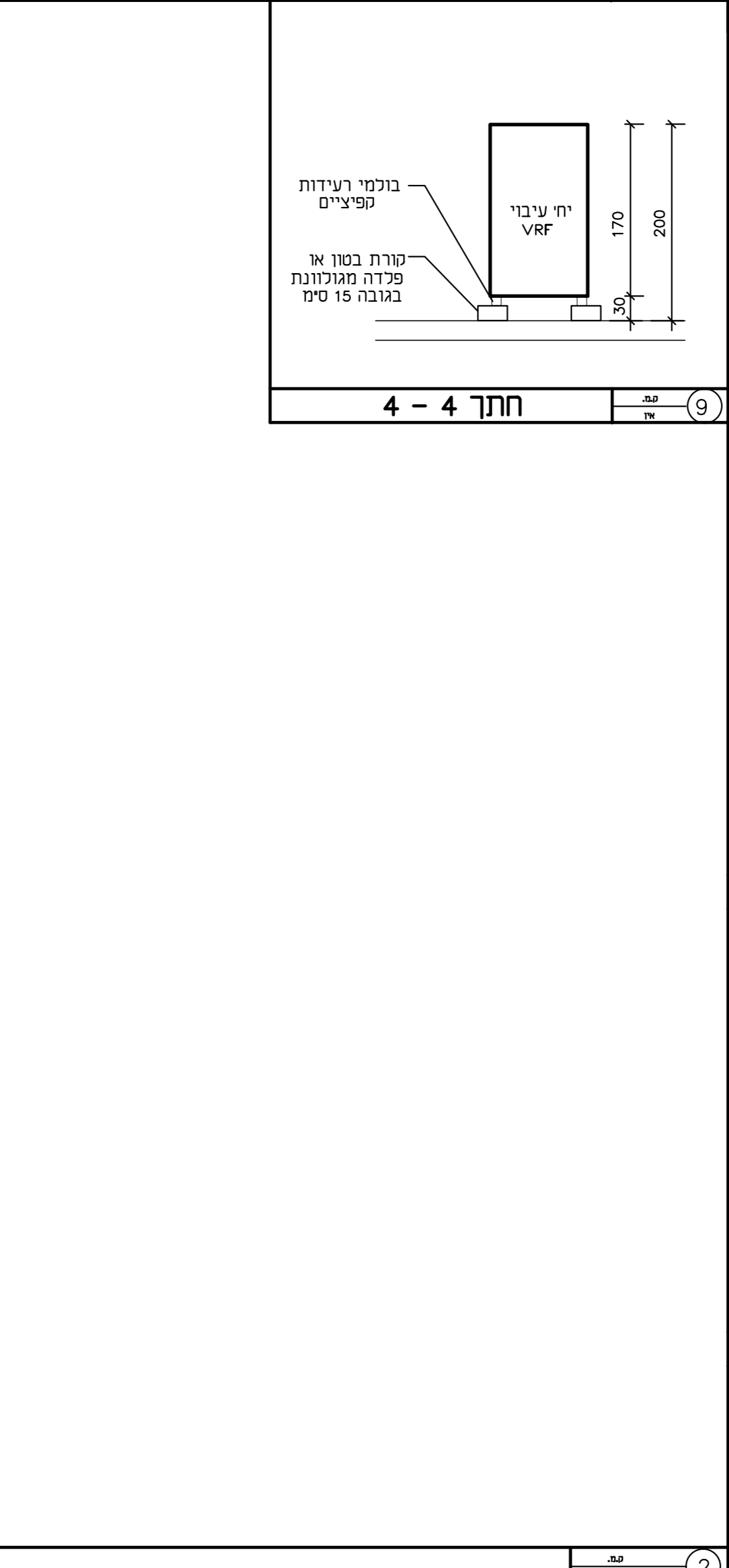
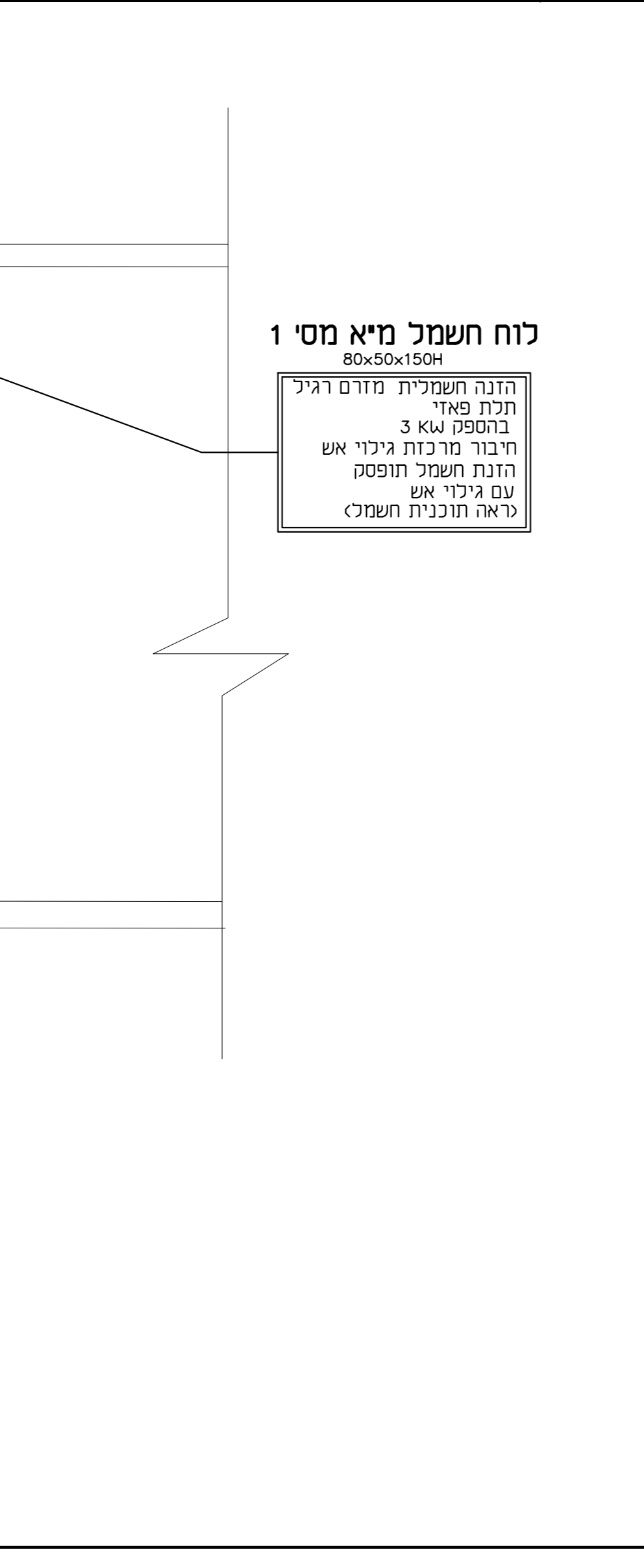
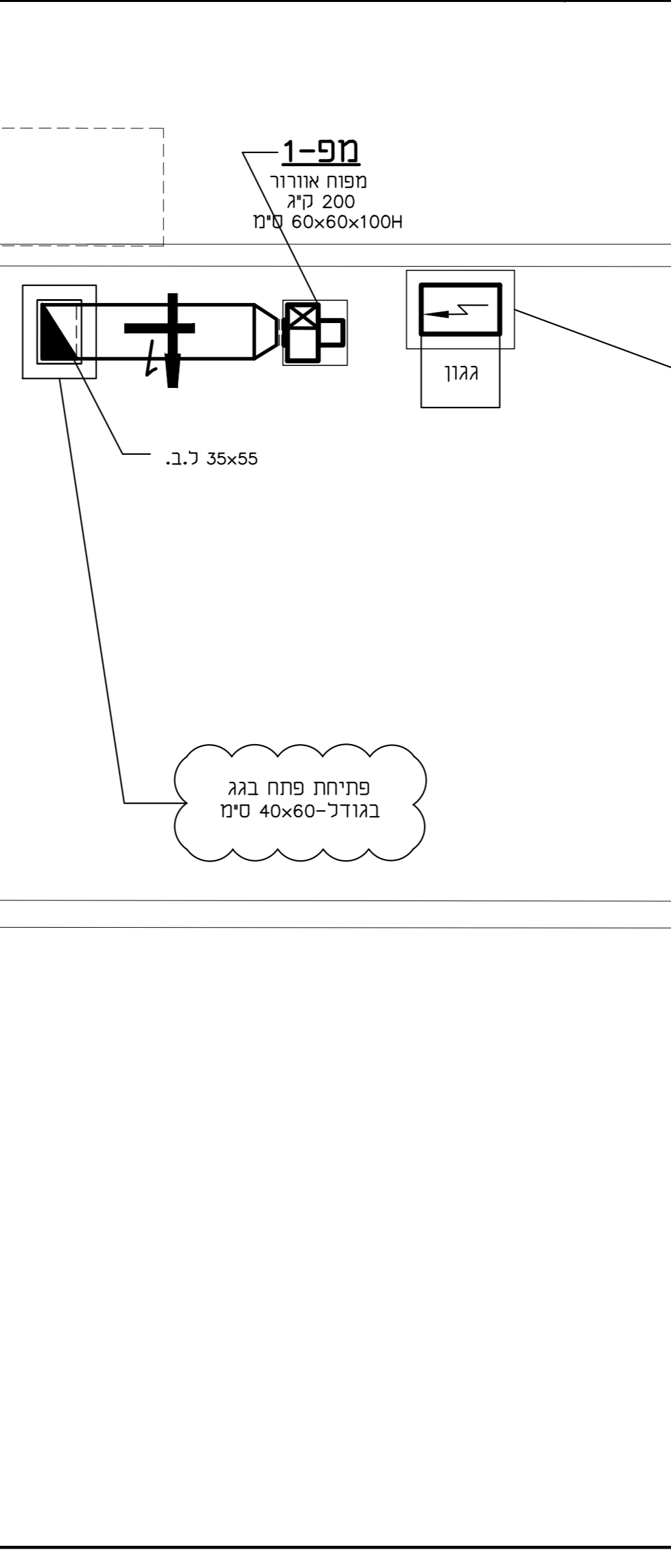
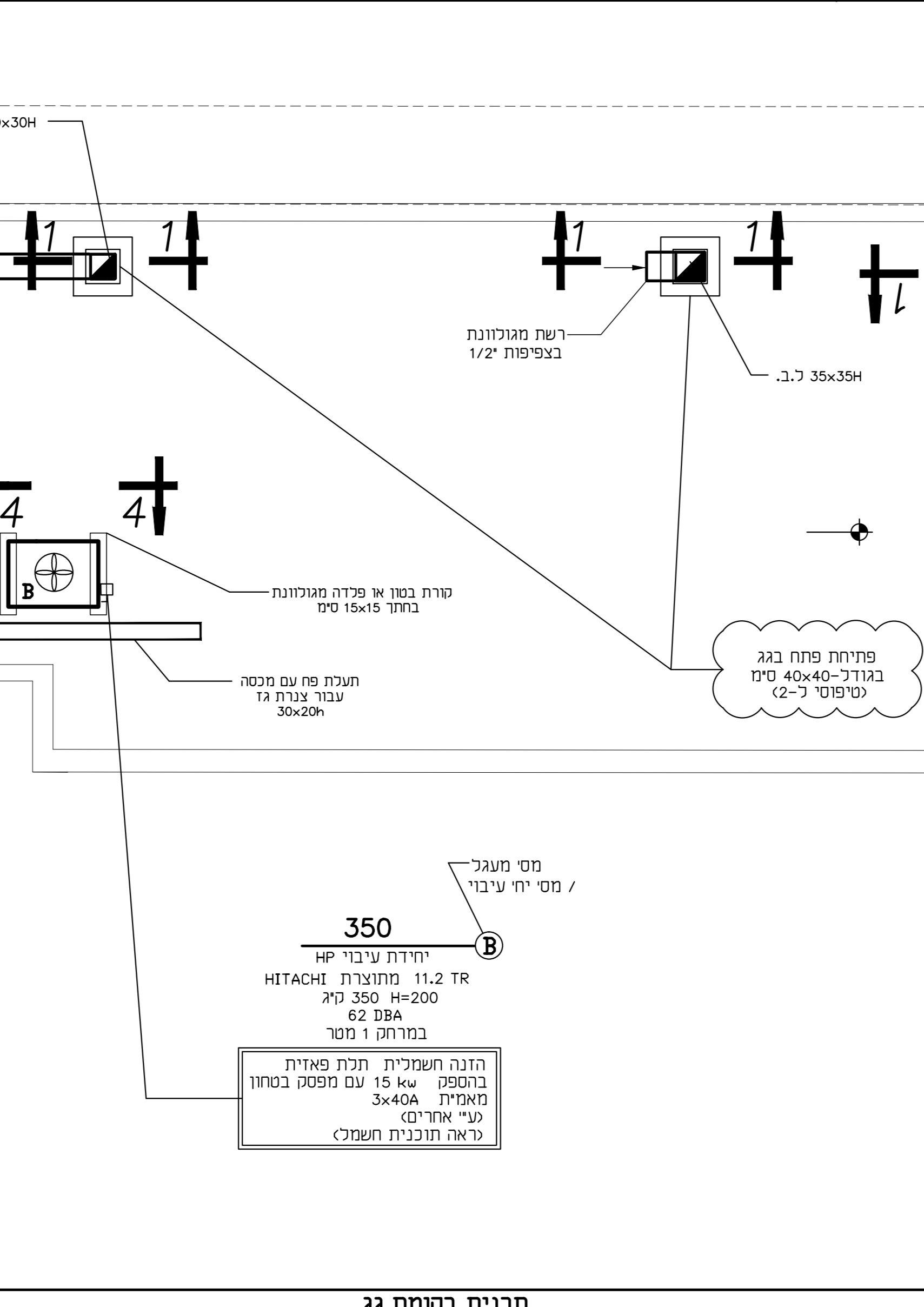
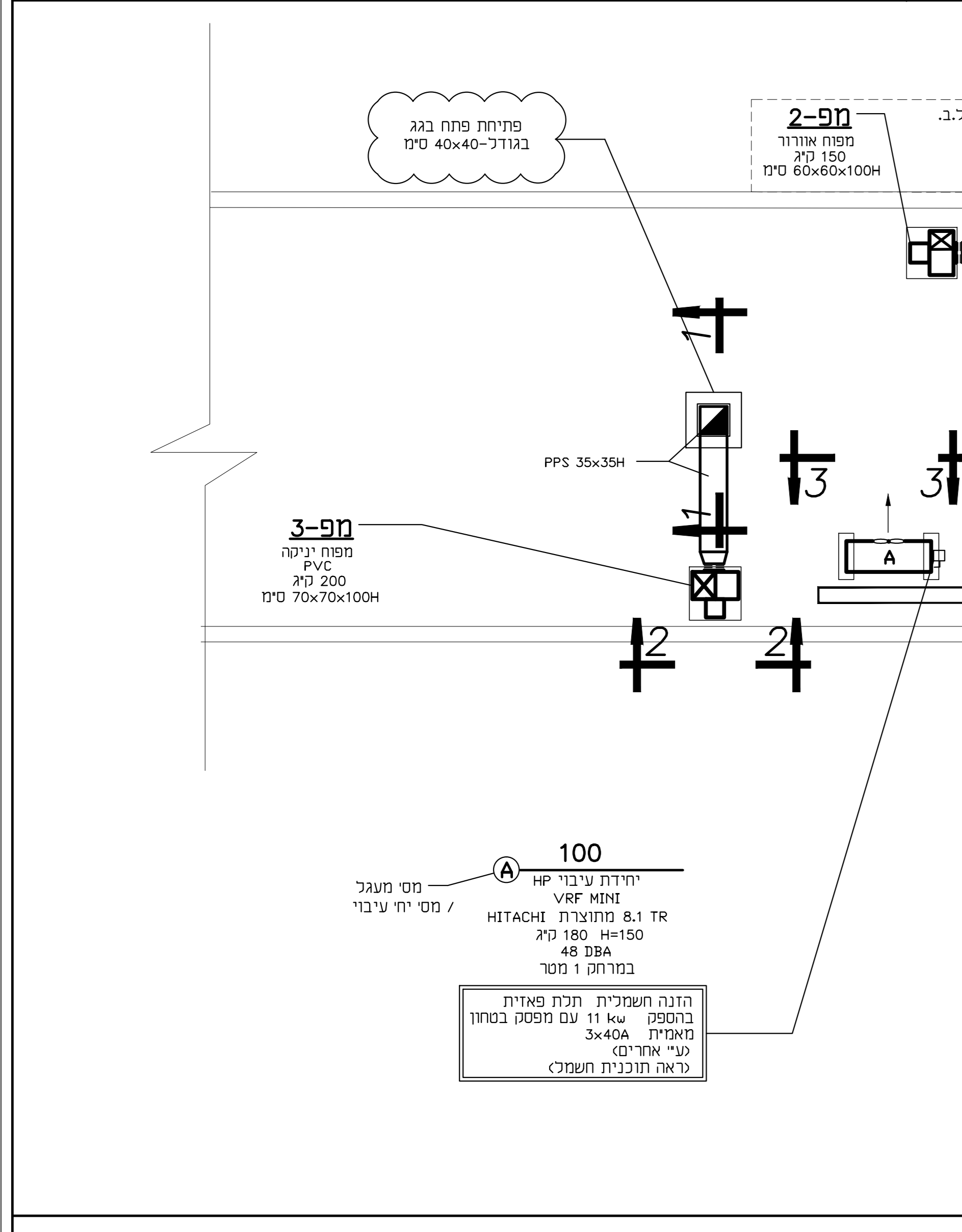
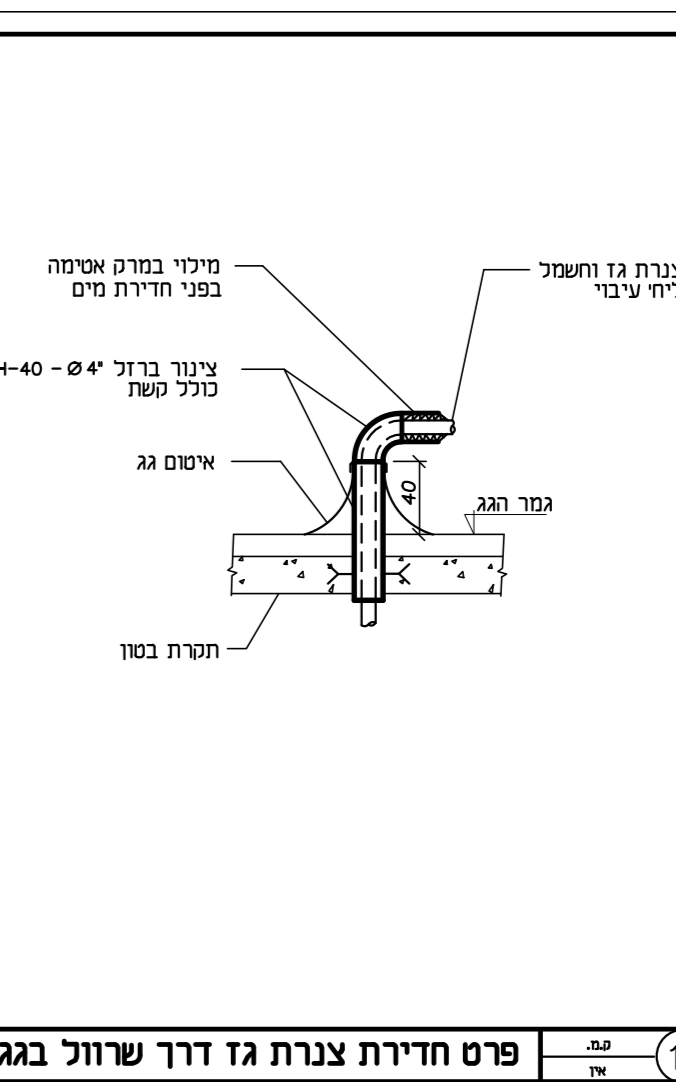
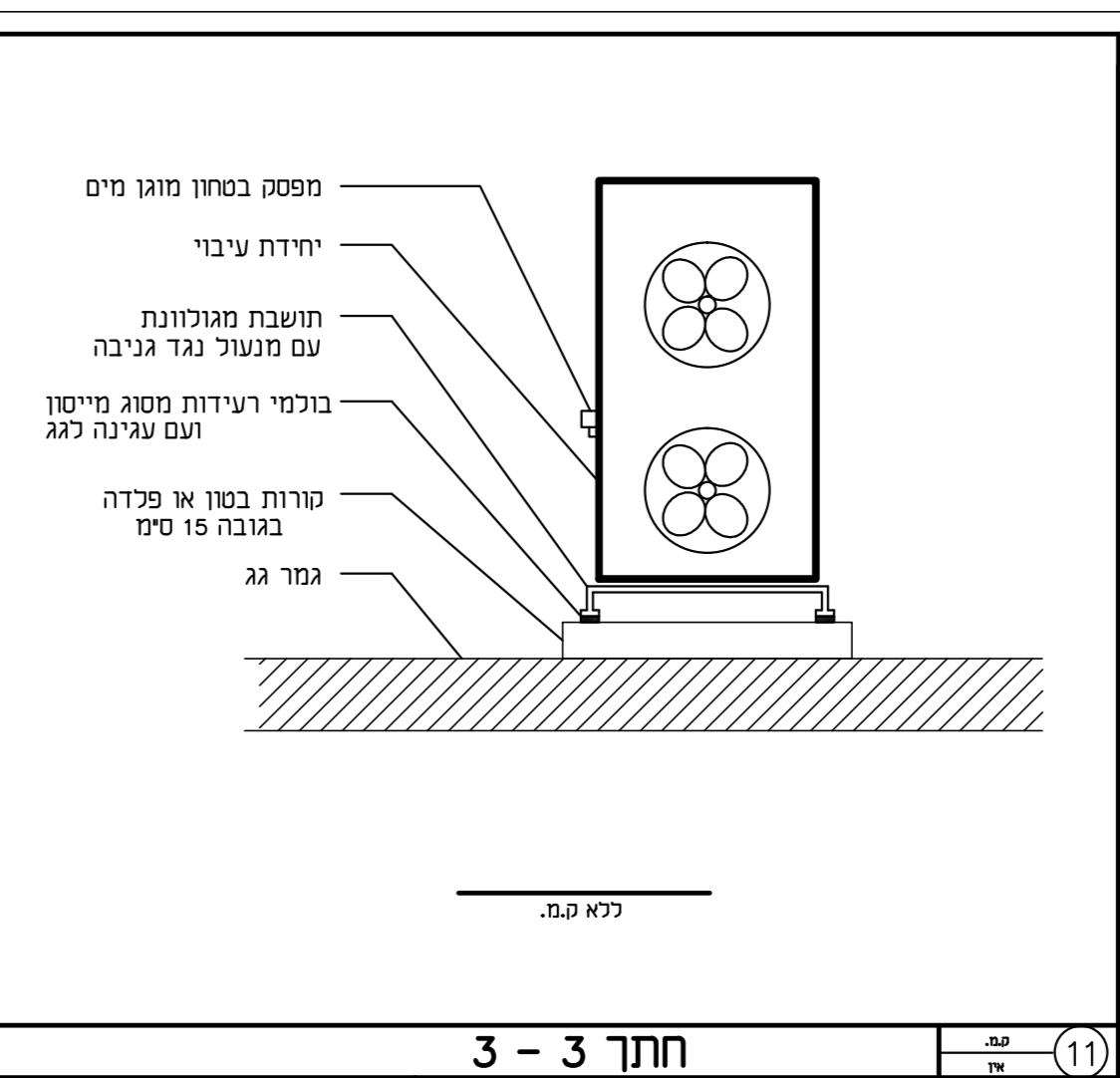
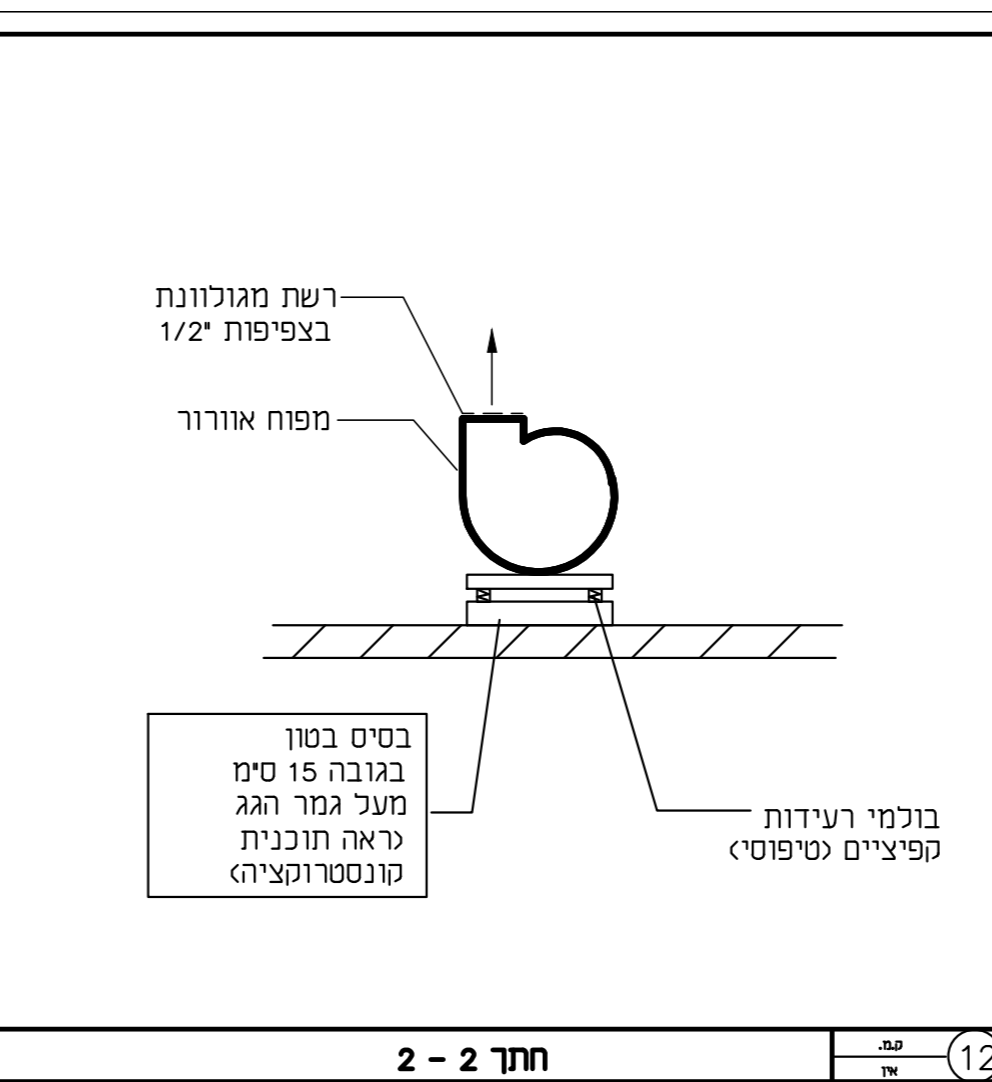
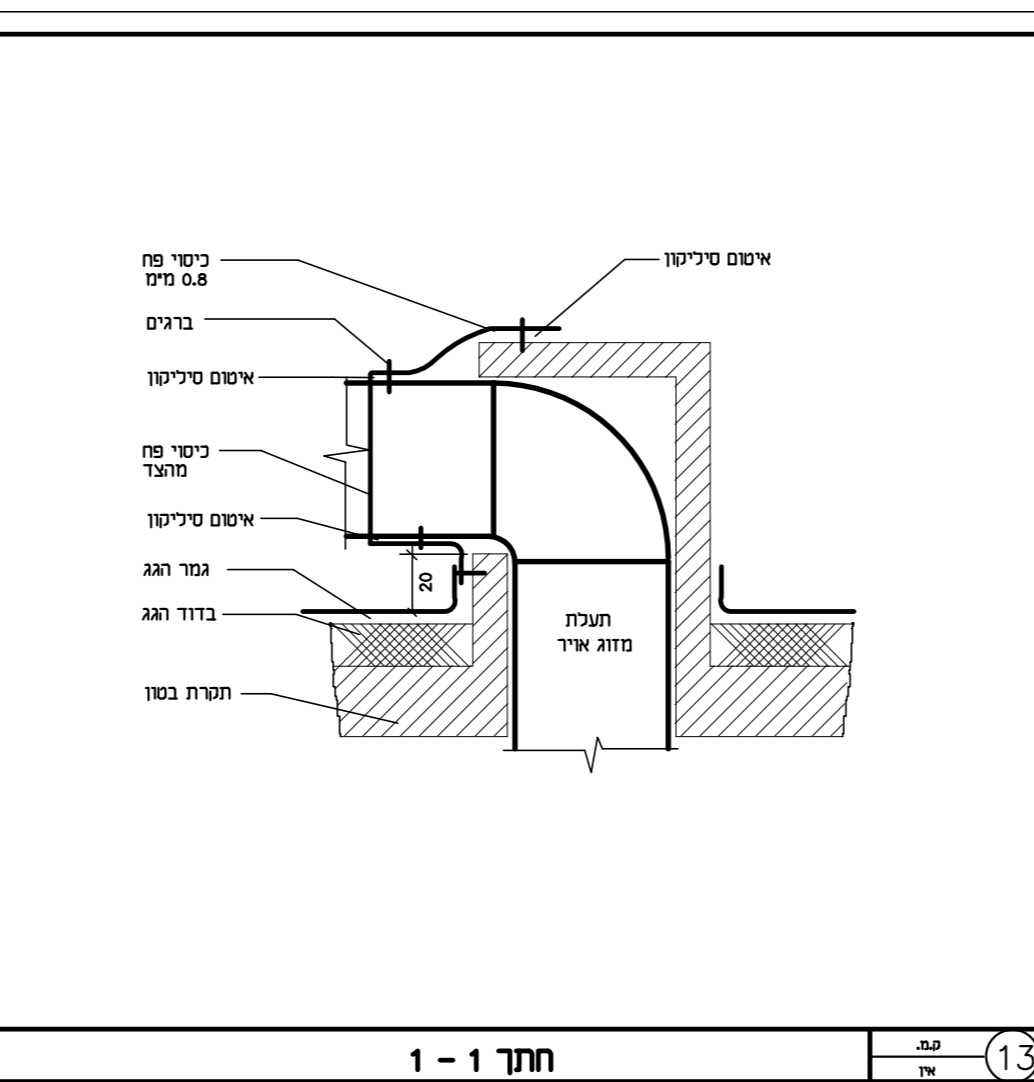
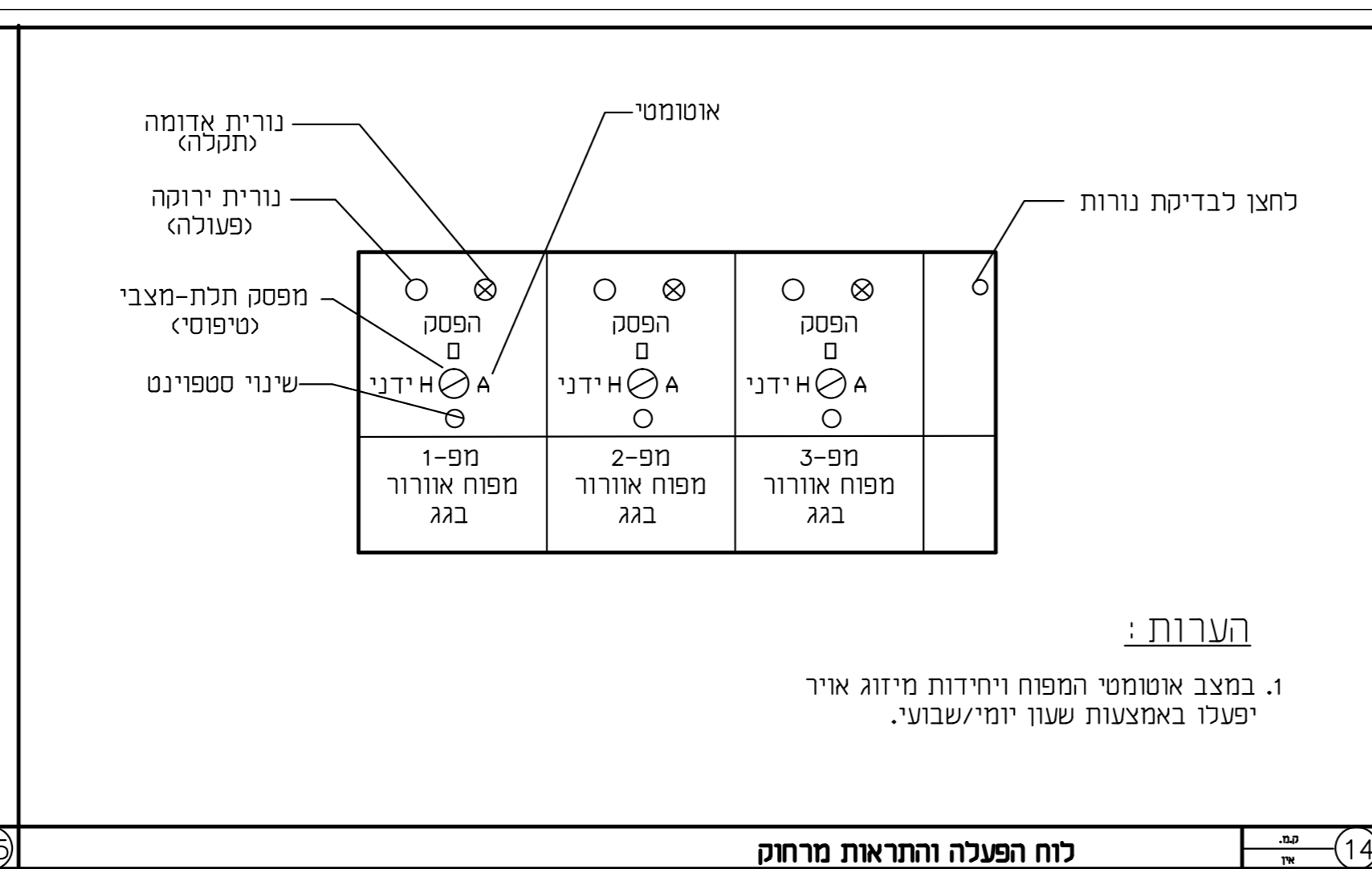
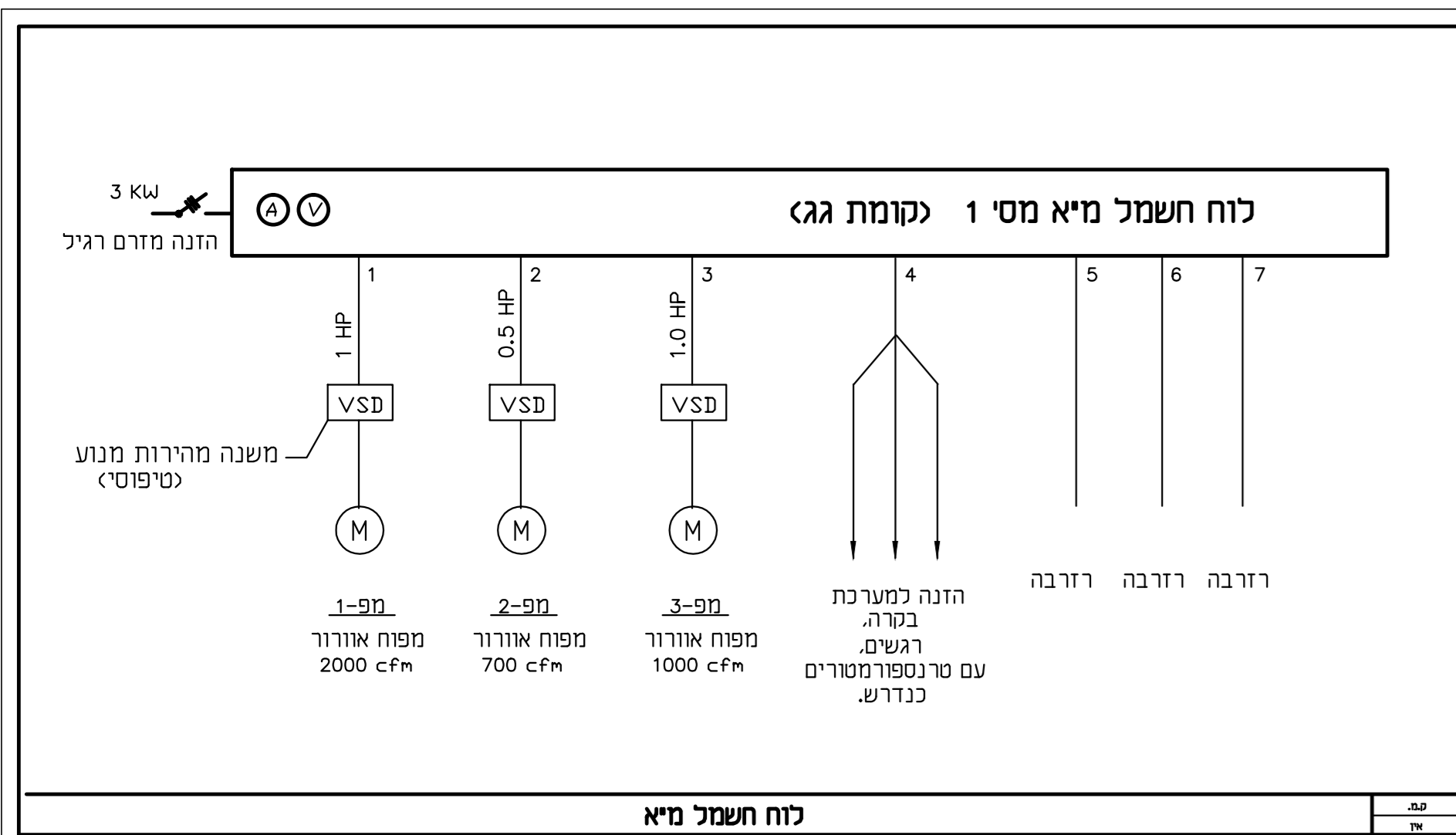
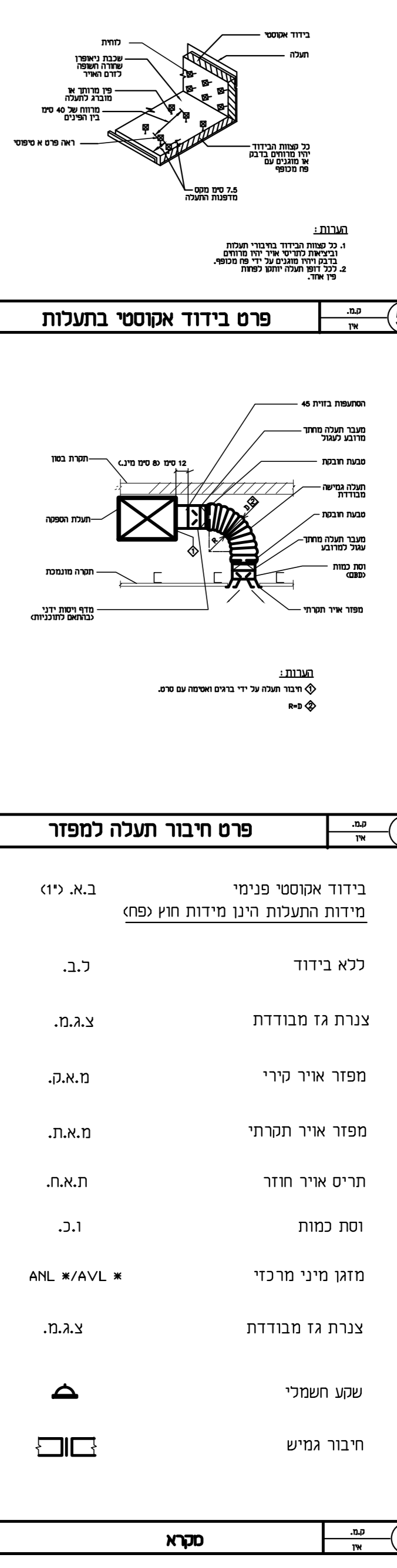
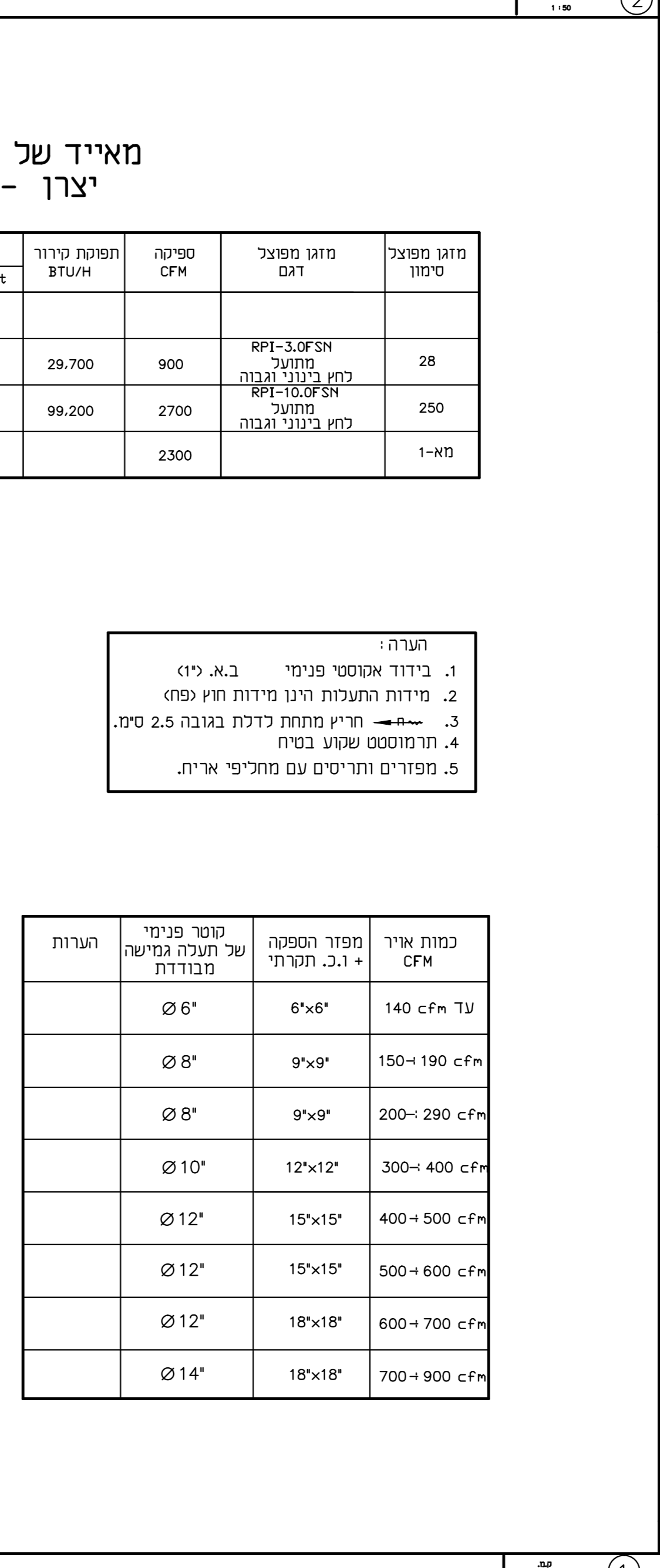
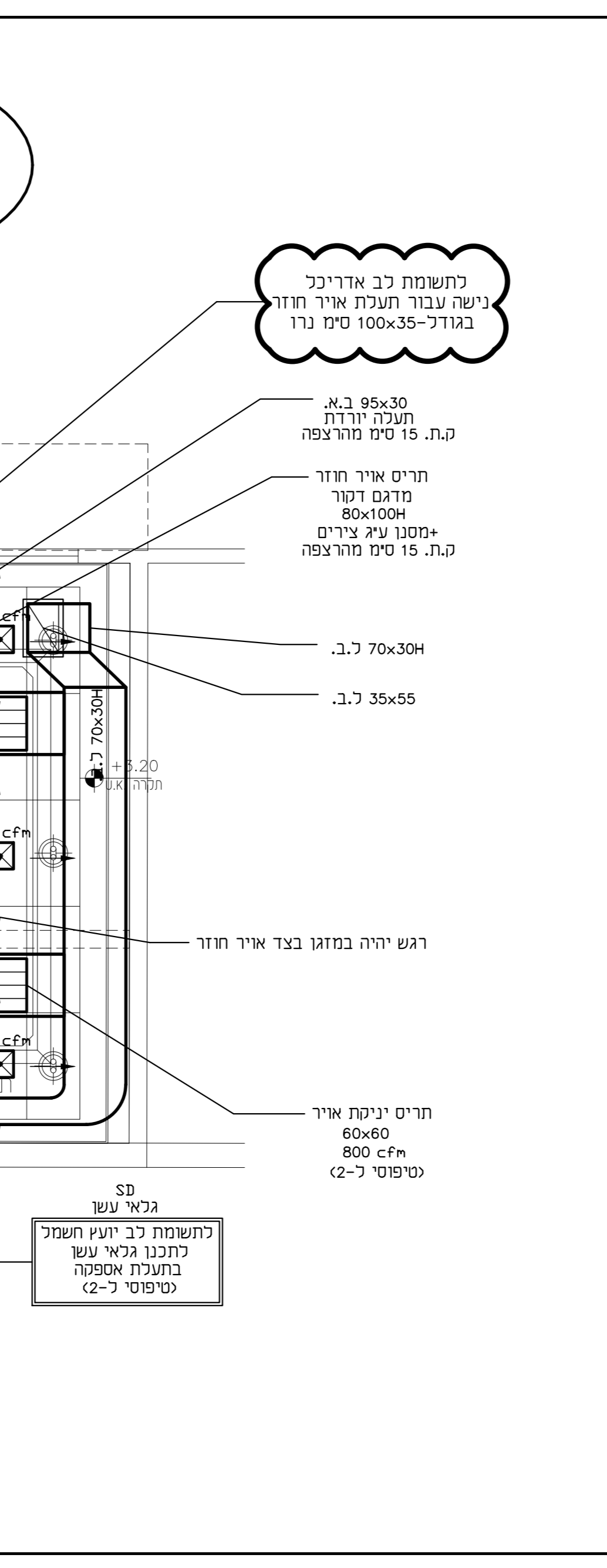
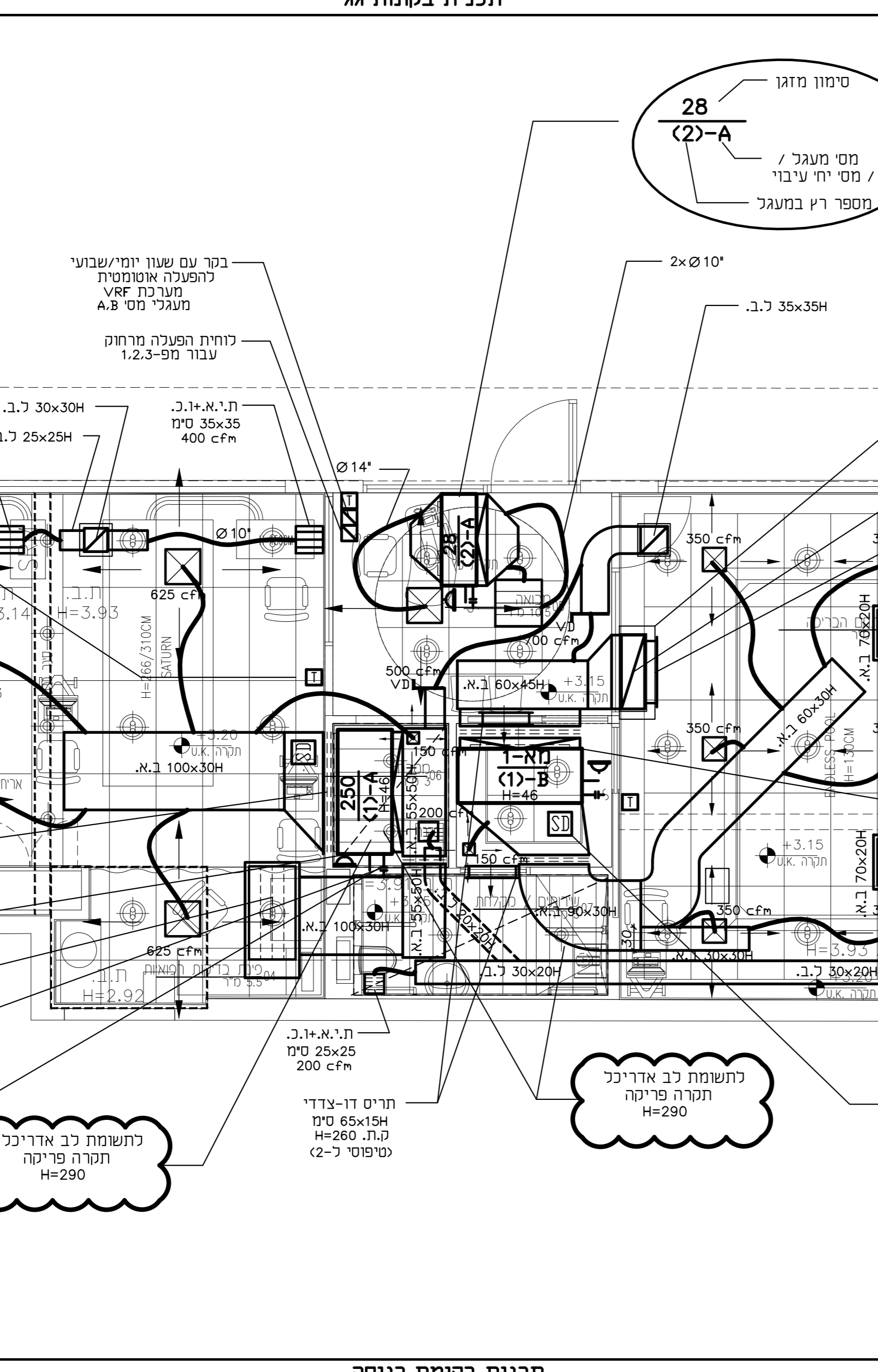
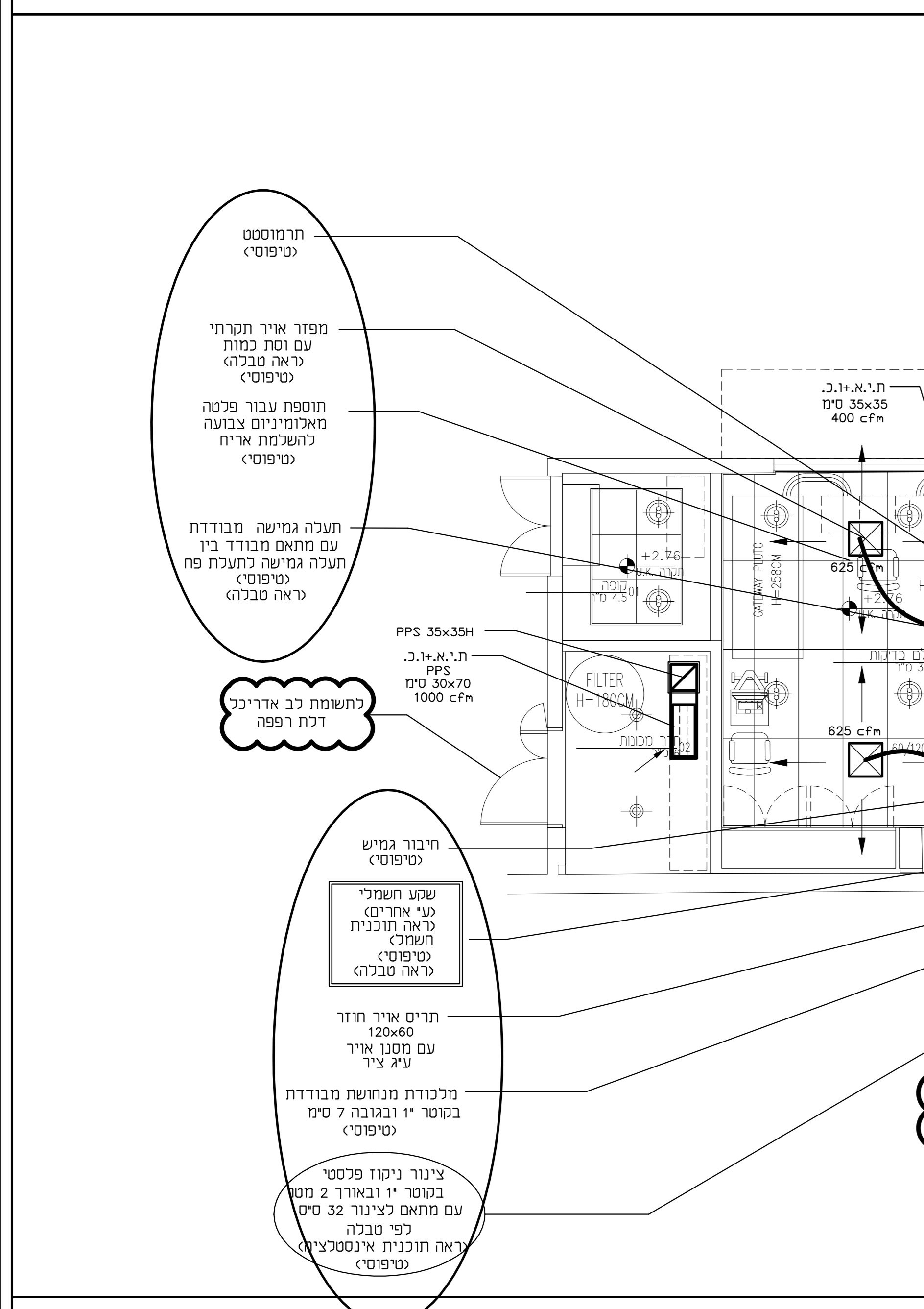

מספר	תאריך	תפוצה
1	14.03.18	
2	20.03.18	
שינוי עדיכון		
מספר	תאריך	

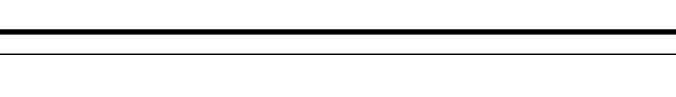
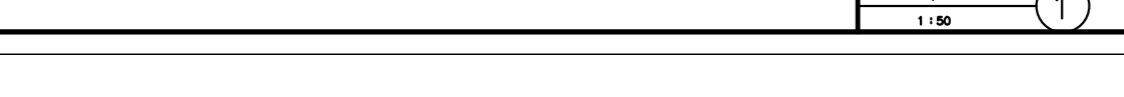
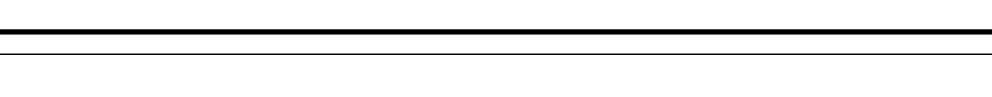
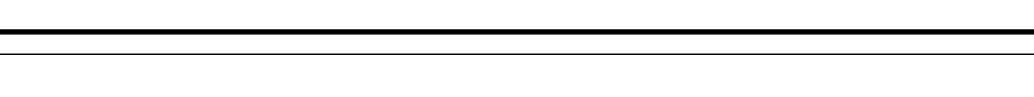
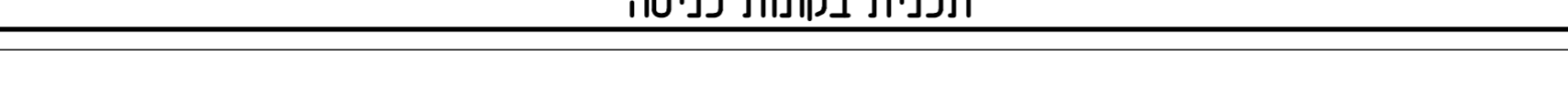
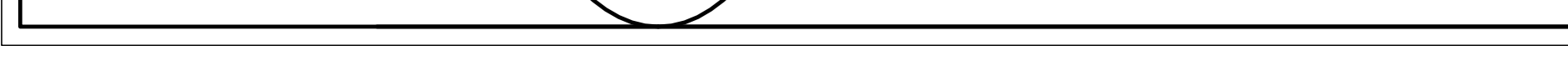

מספר	תאריך	תפוצה
1	14.03.18	
2	20.03.18	
שינוי עדיכון		
מספר	תאריך	

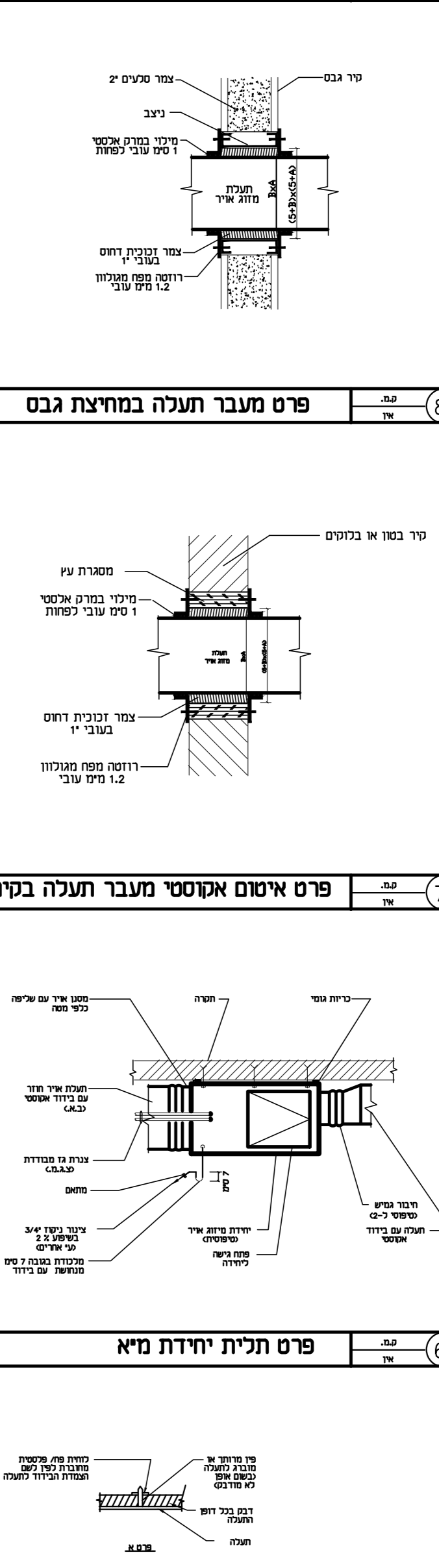
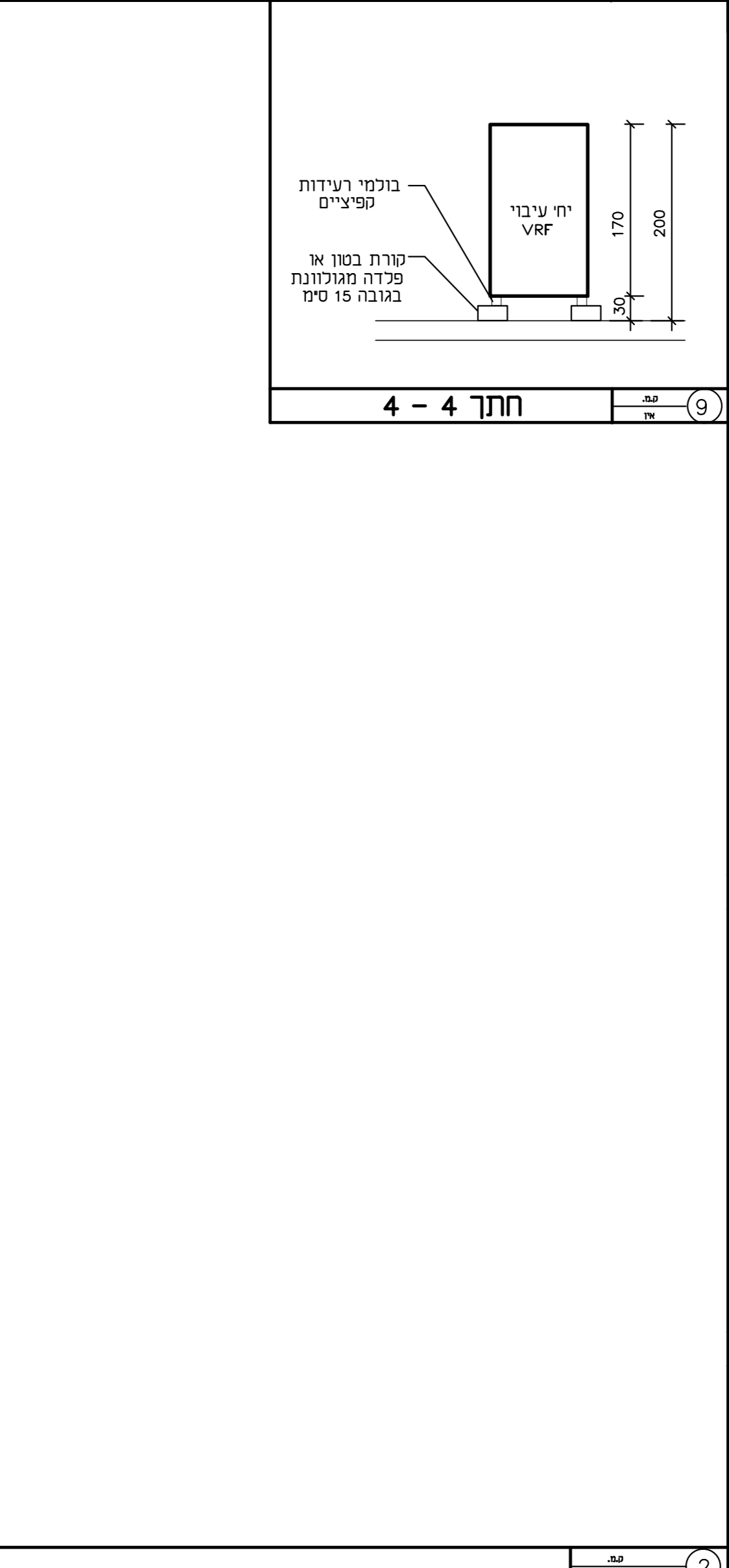
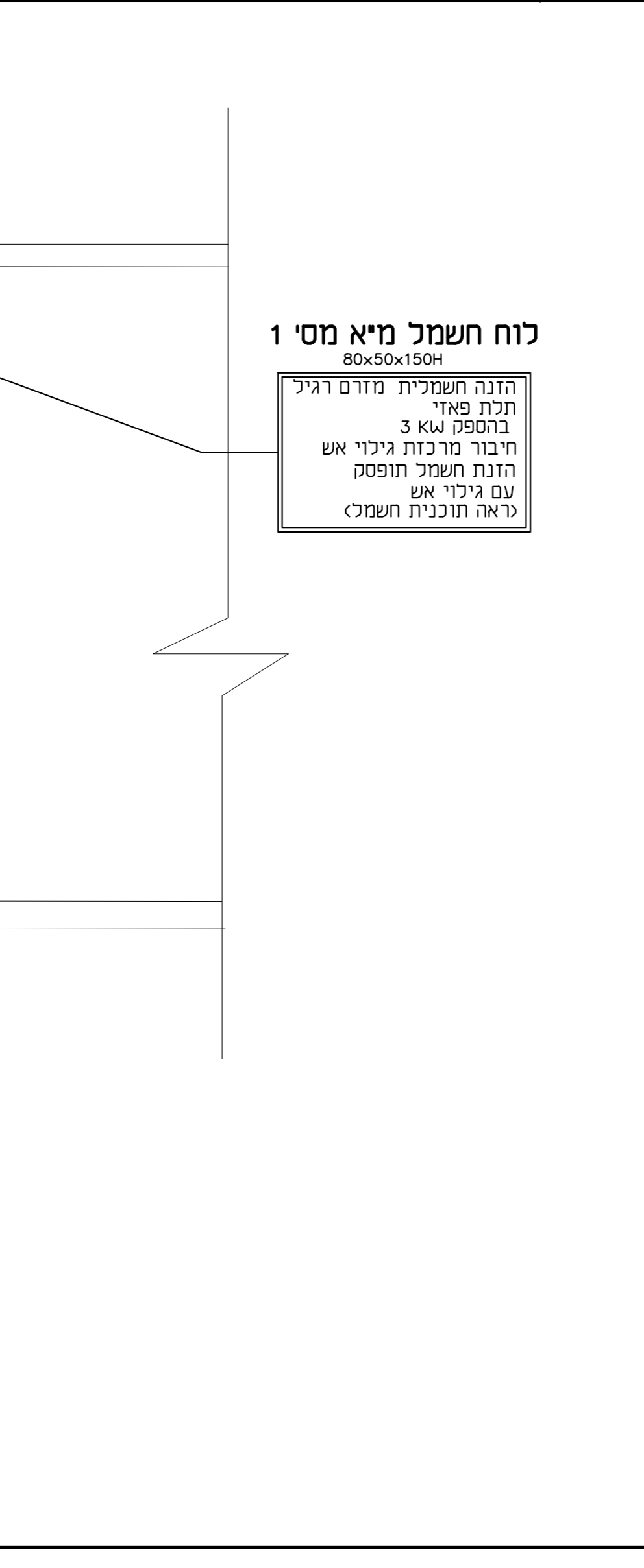
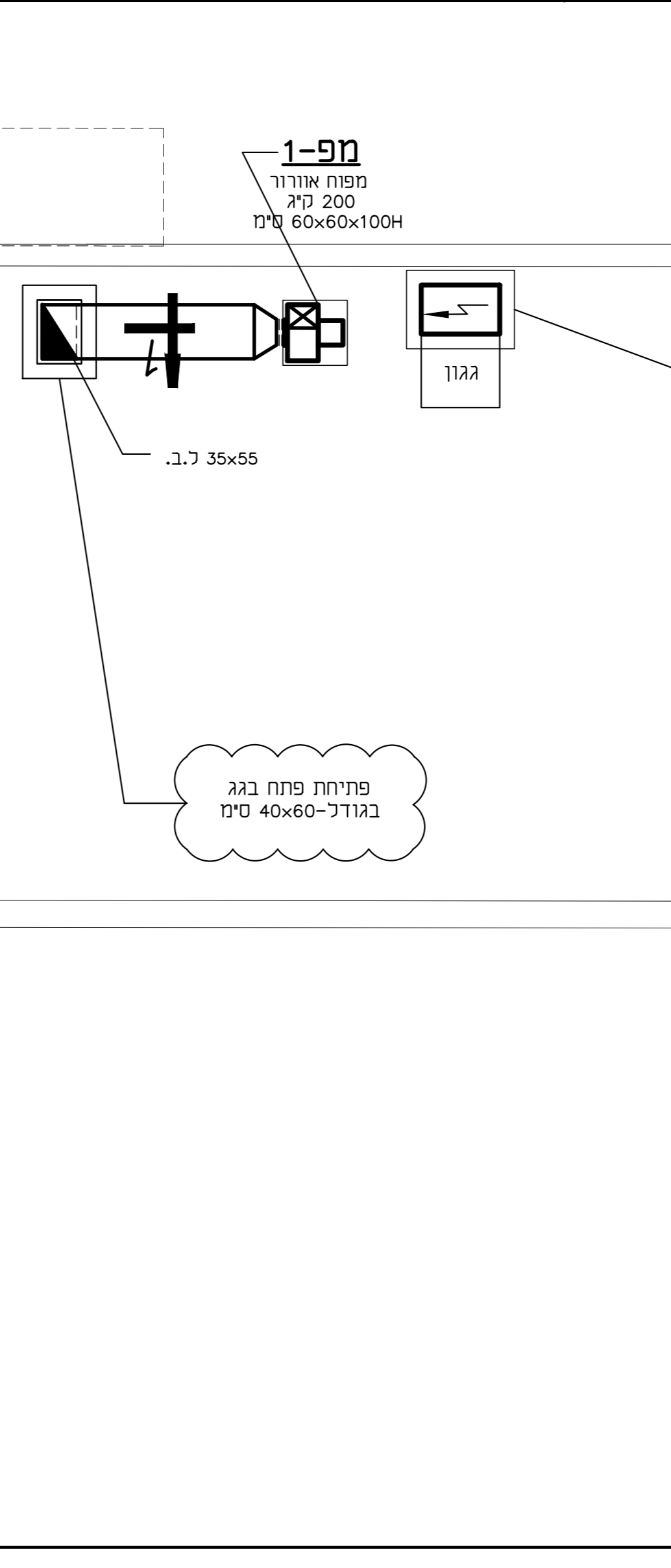
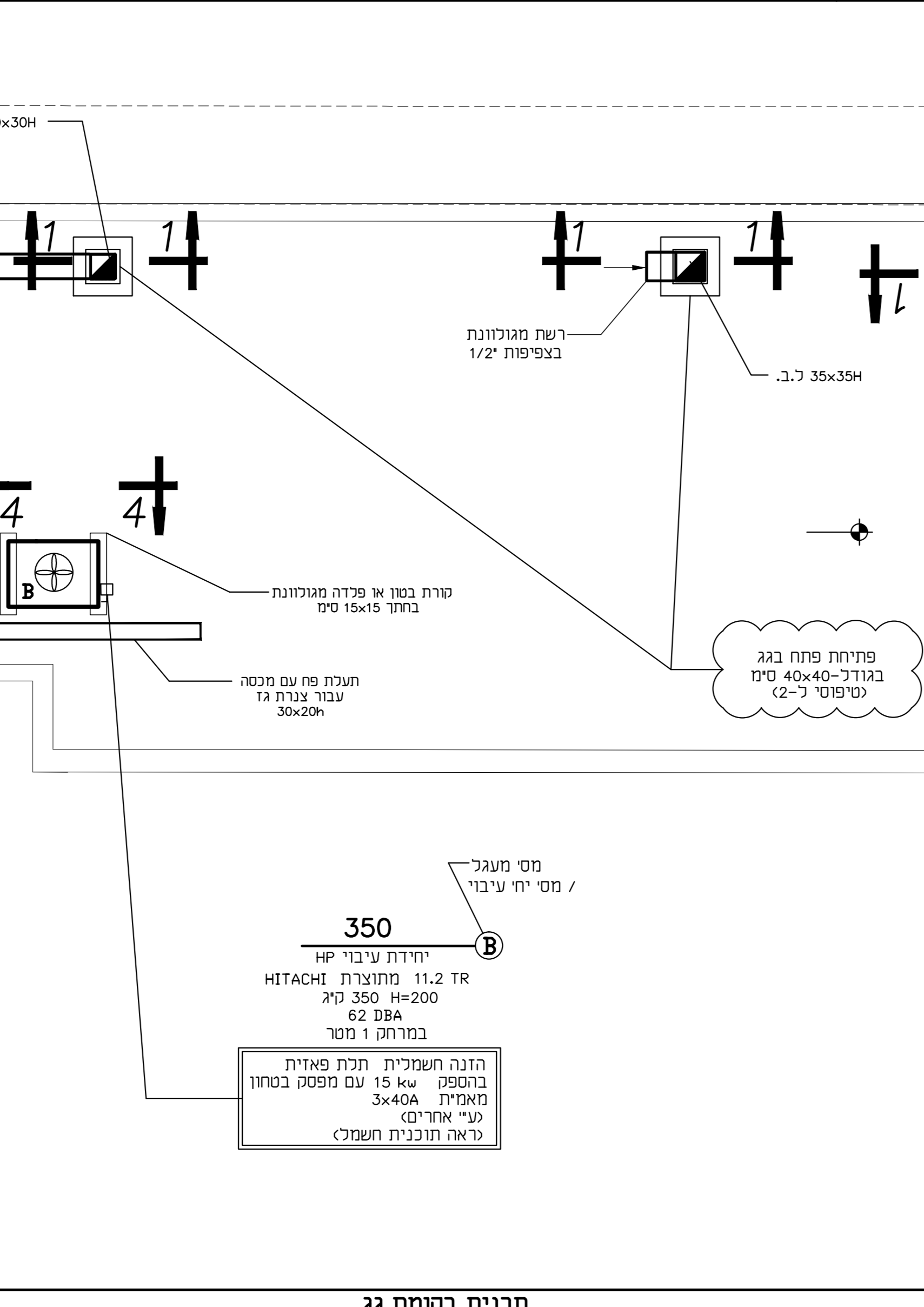
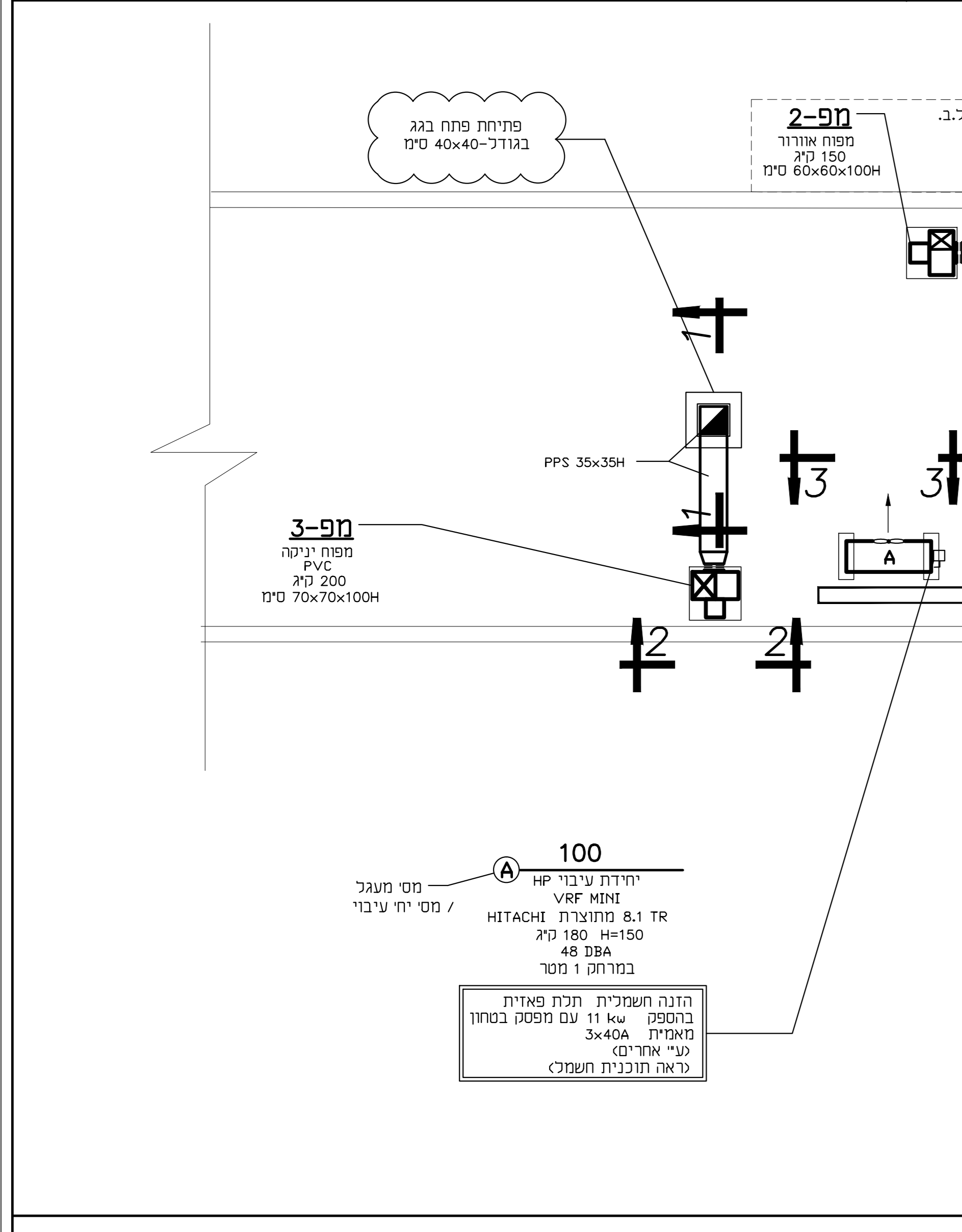
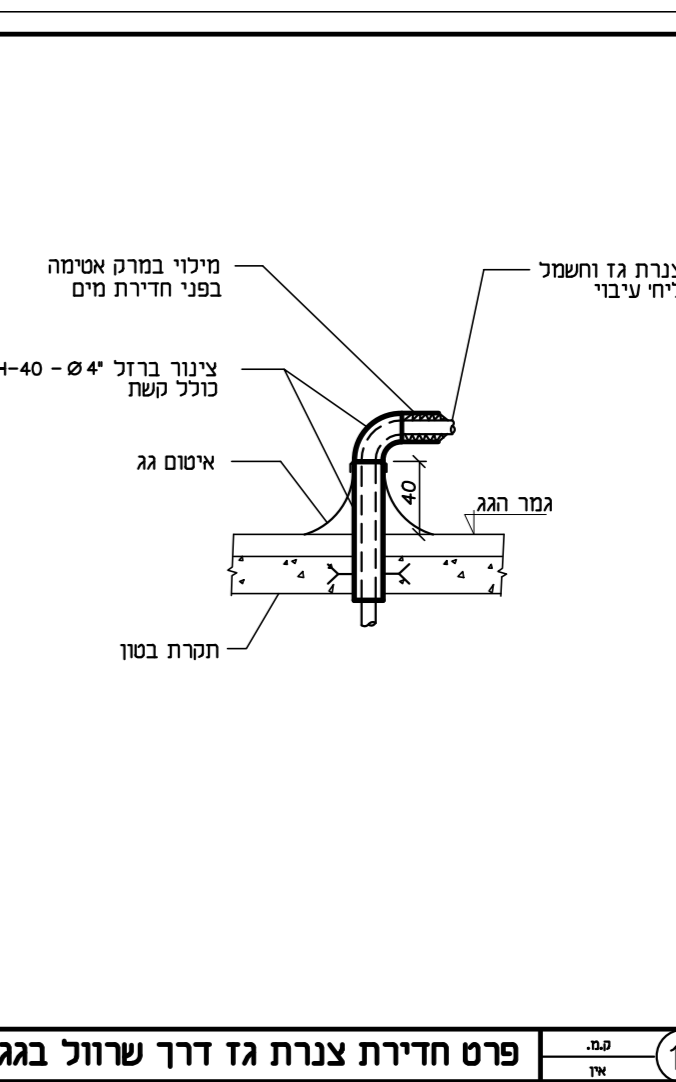
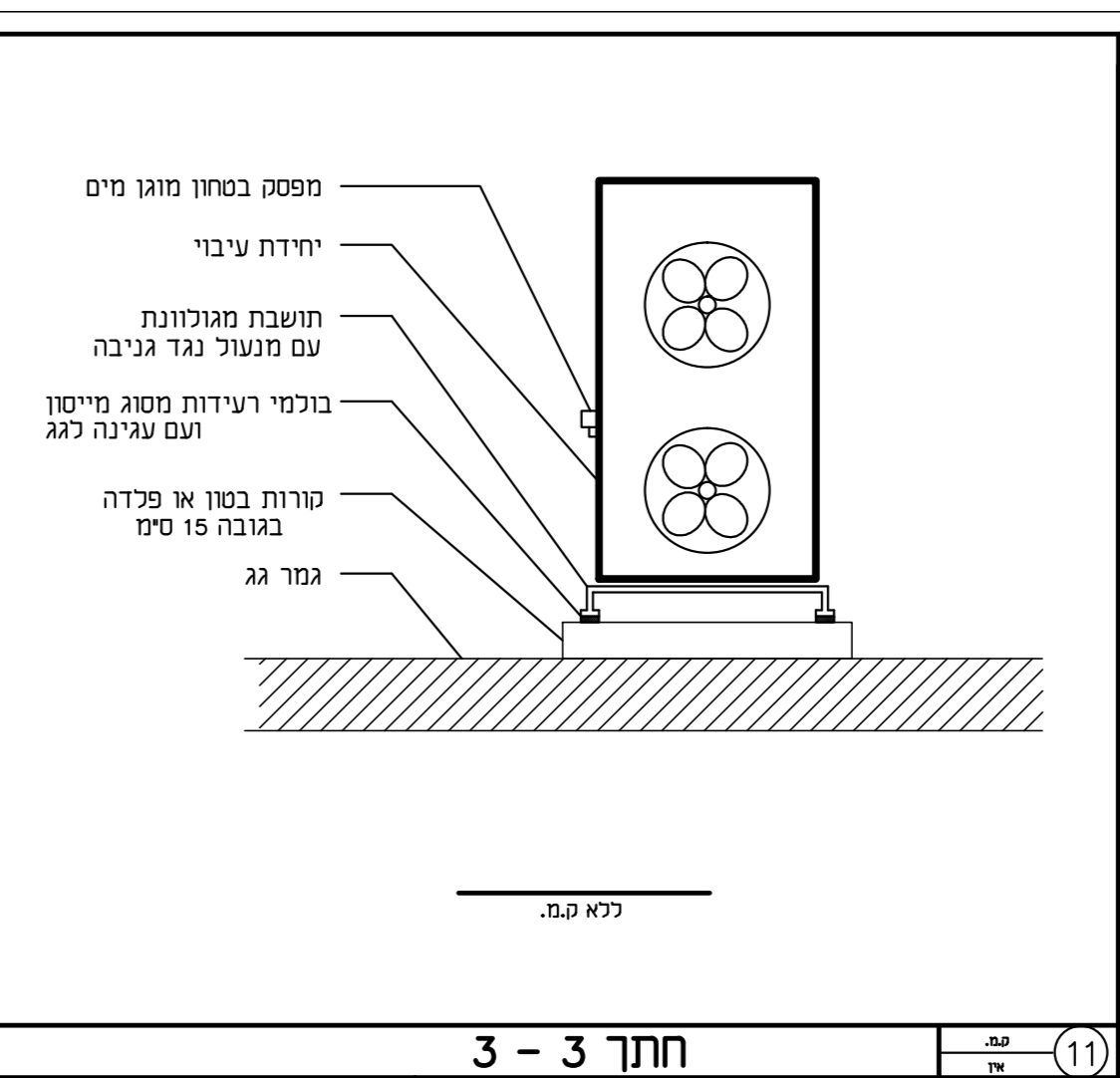
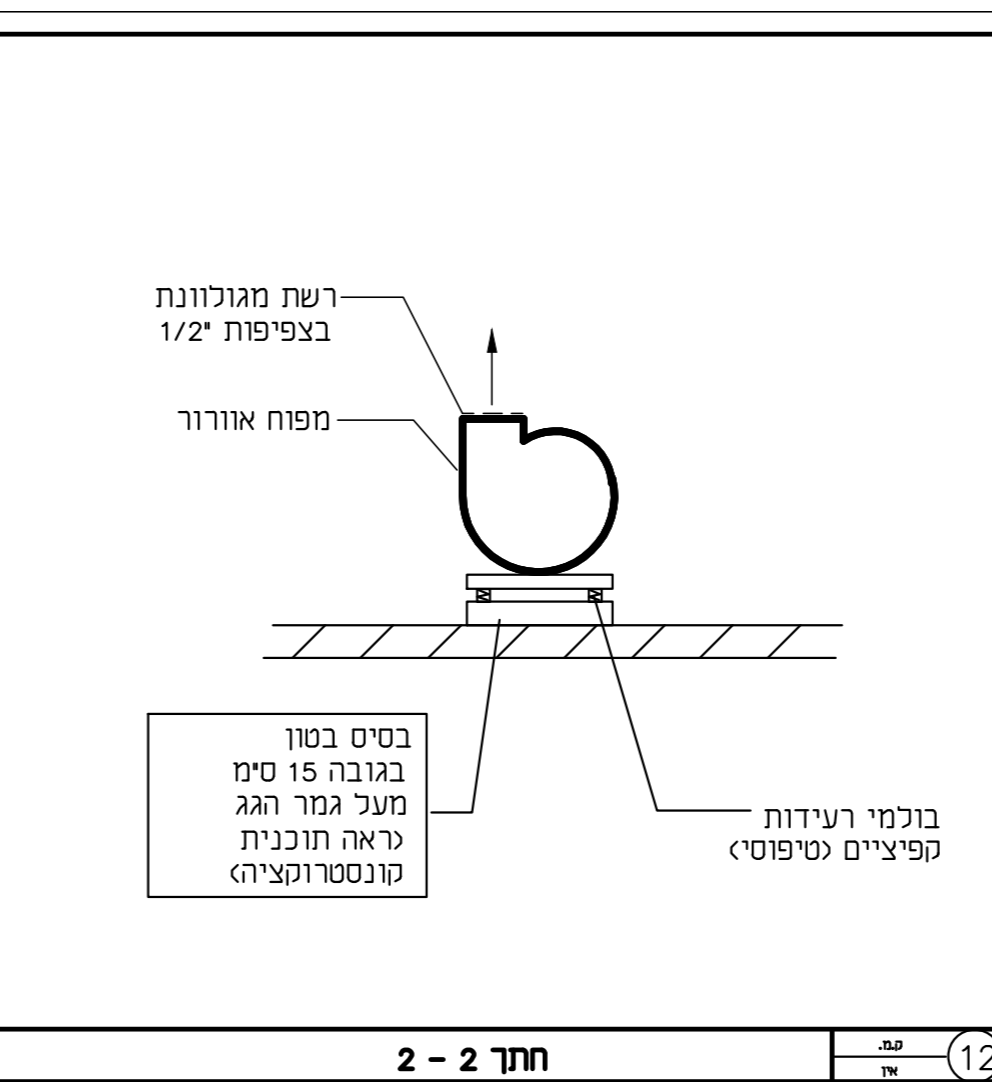
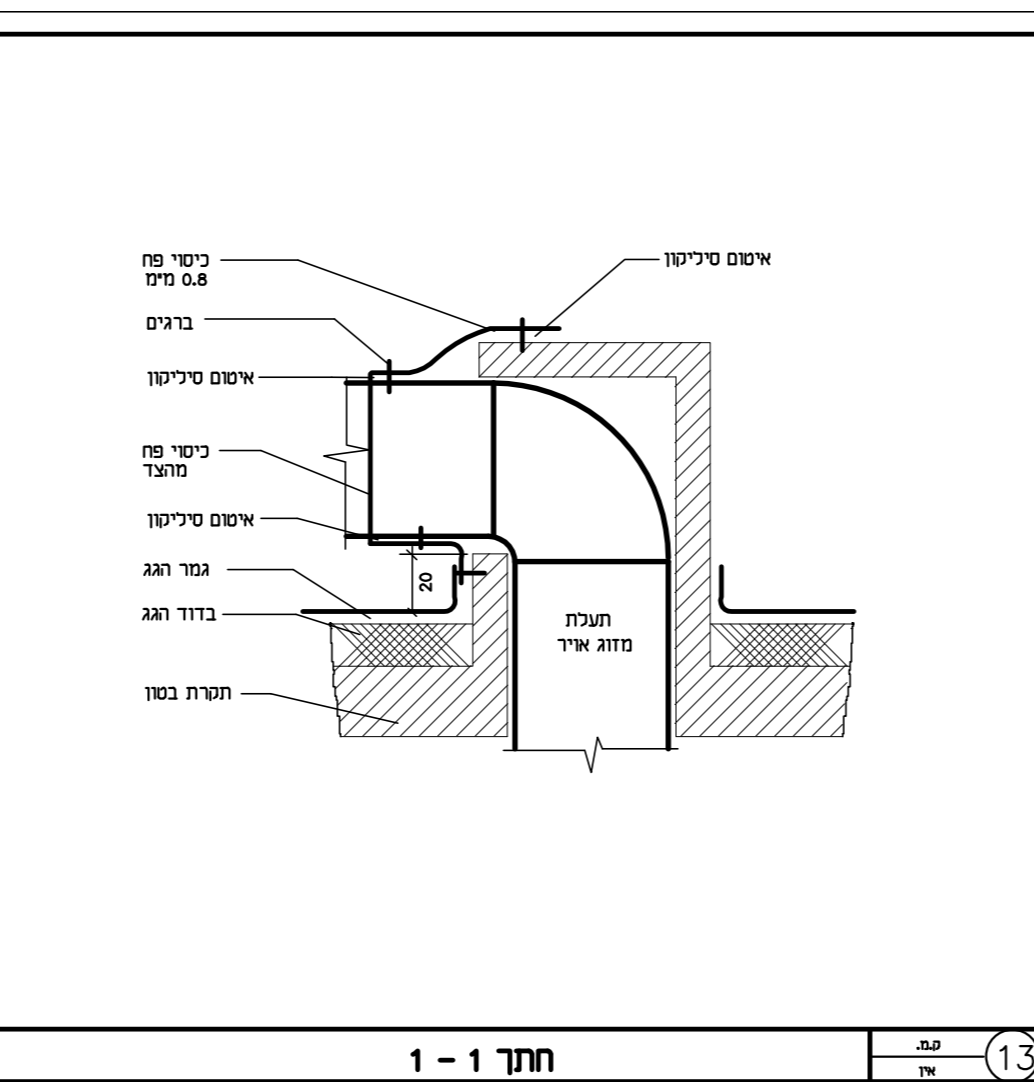
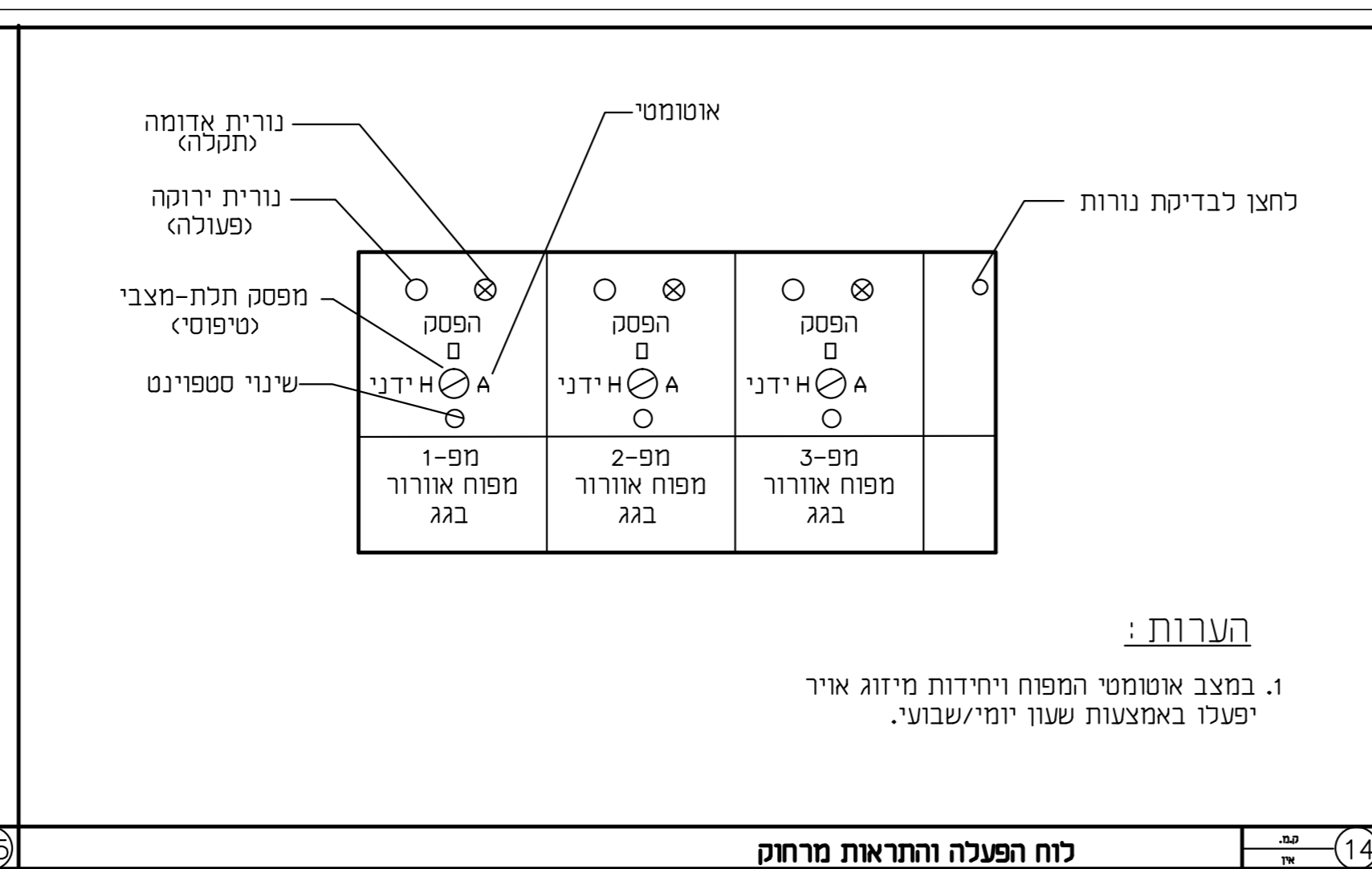
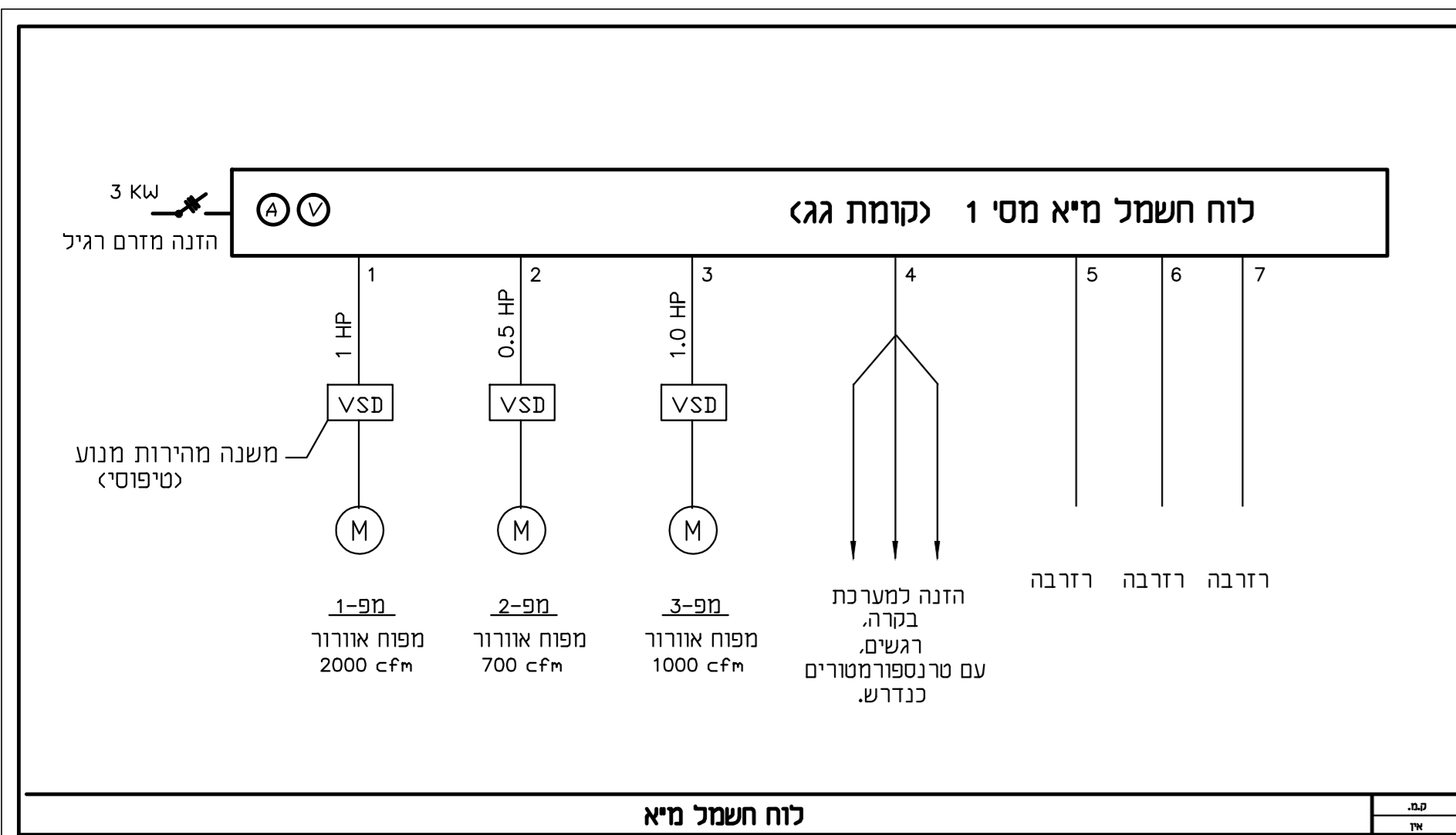

מספר	תאריך	תפוצה
1	14.03.18	
2	20.03.18	
שינוי עדיכון		
מספר	תאריך	

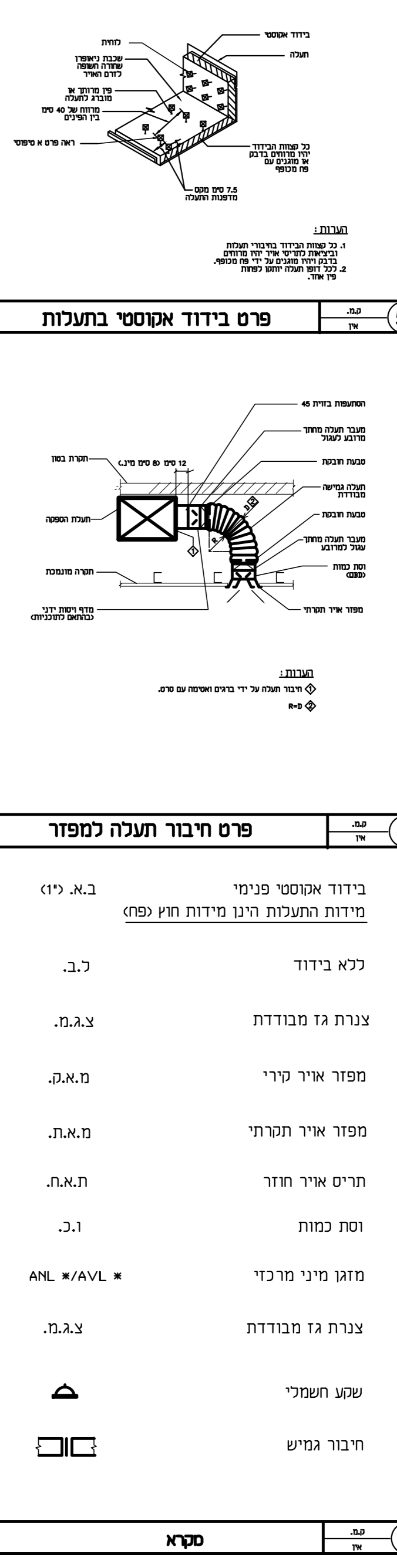
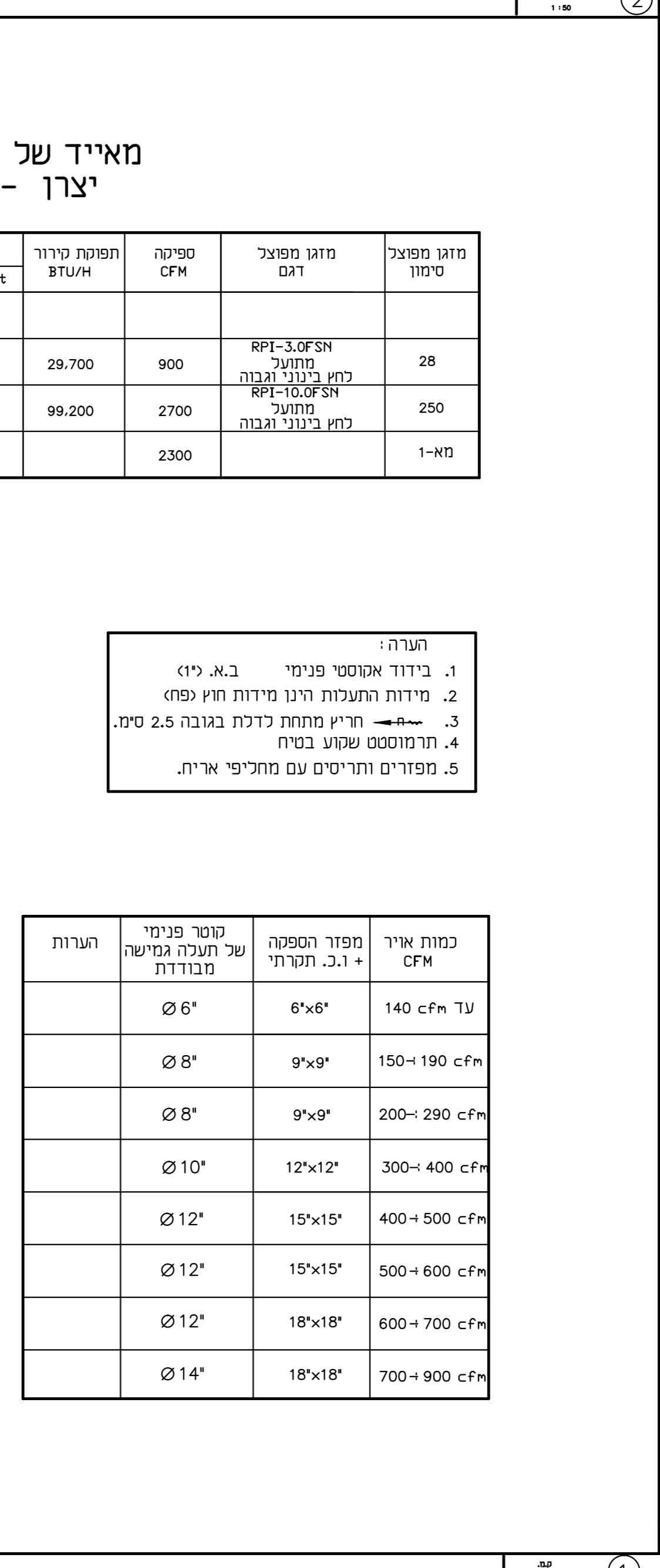
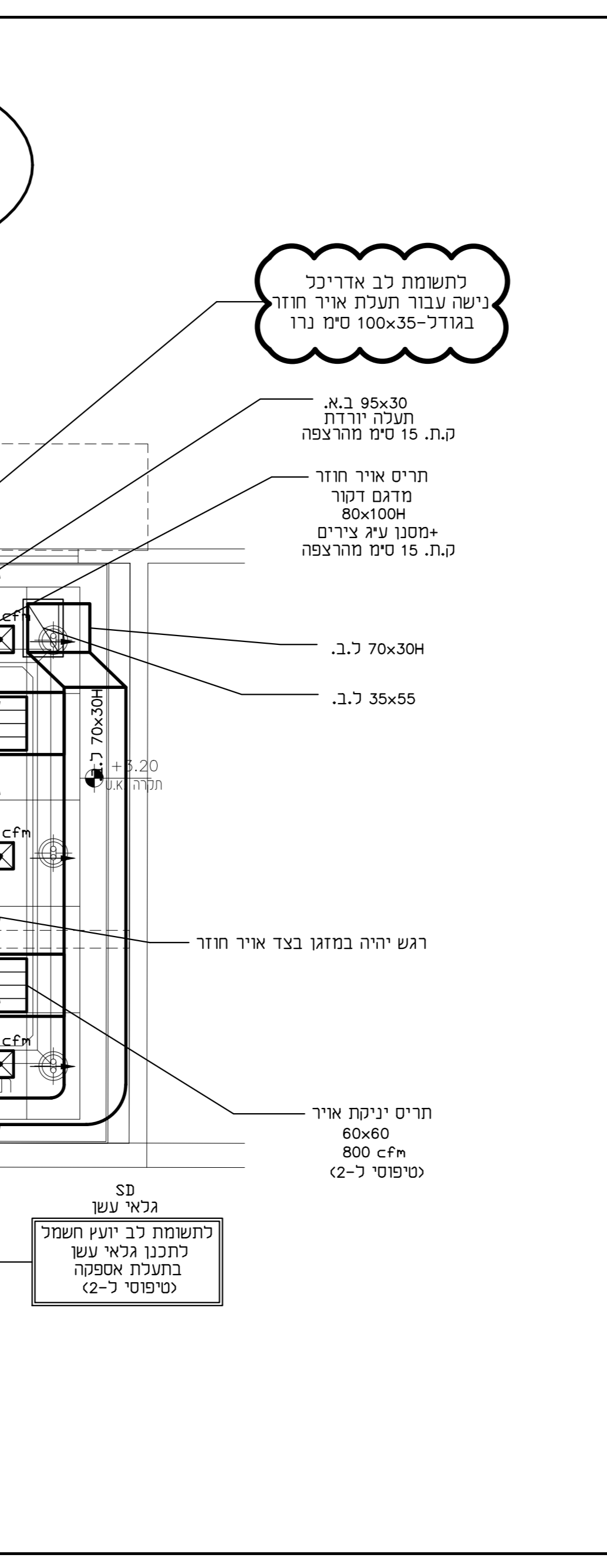
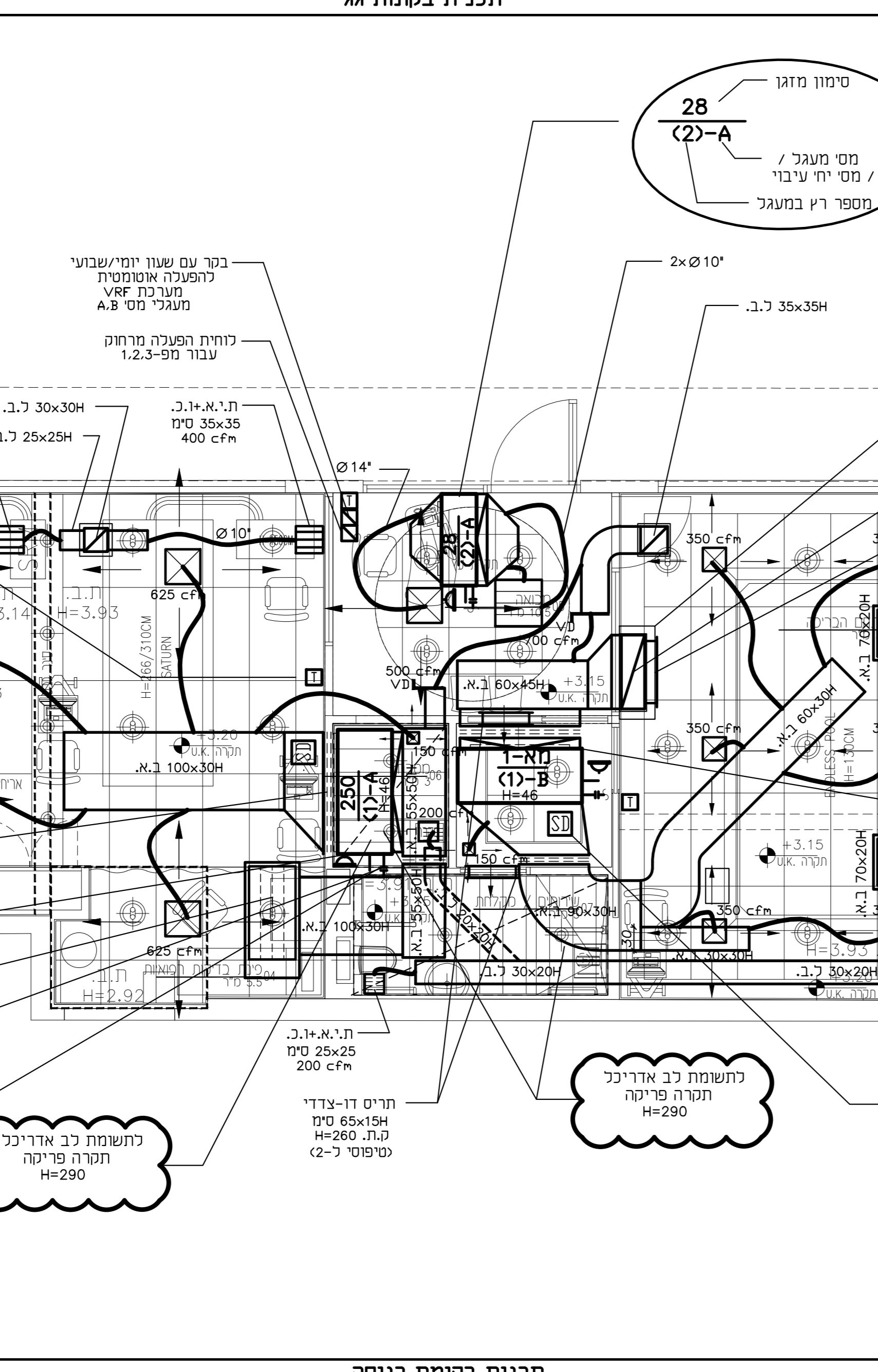
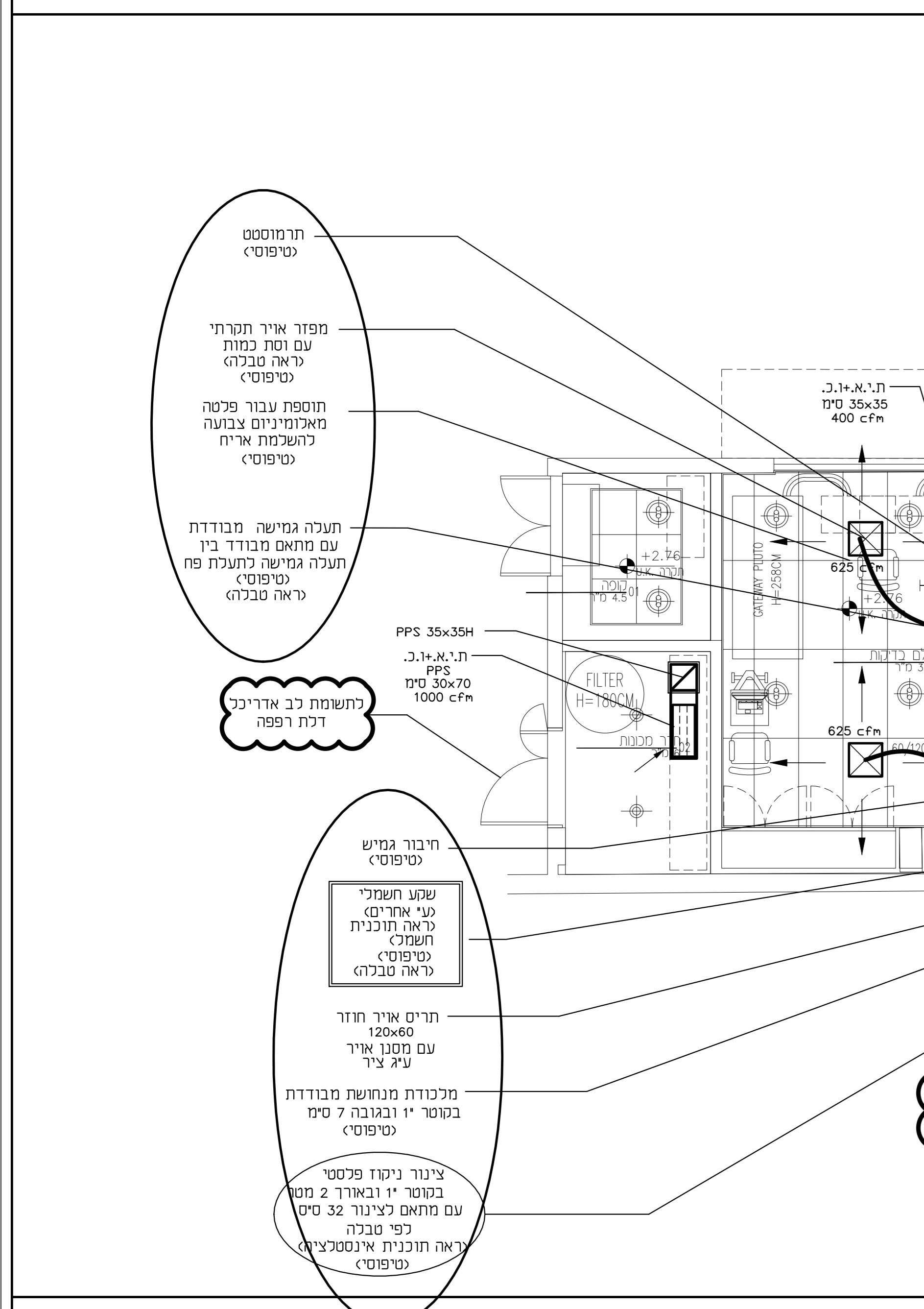

מספר	תאריך	תפוצה
1	14.03.18	
2	20.03.18	
שינוי עדיכון		
מספר	תאריך	

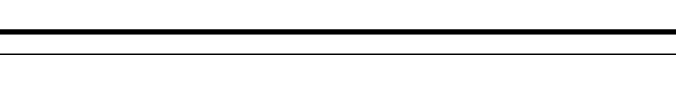
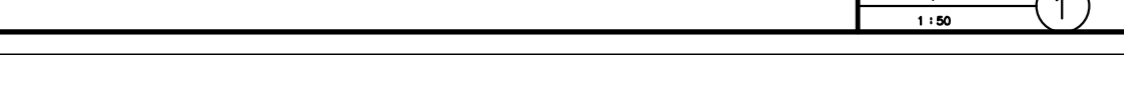
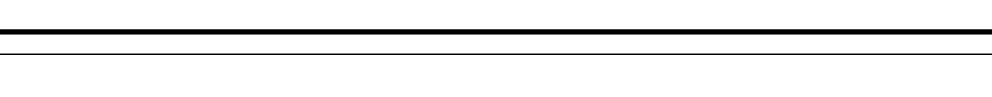
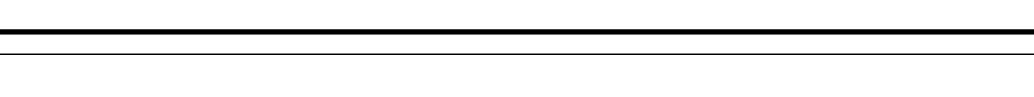
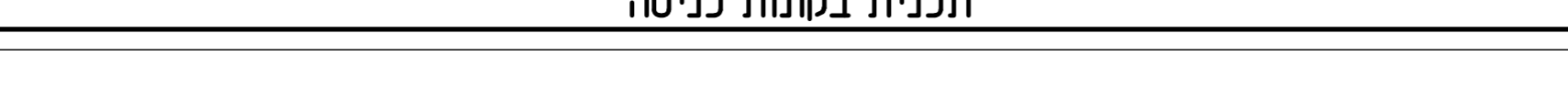
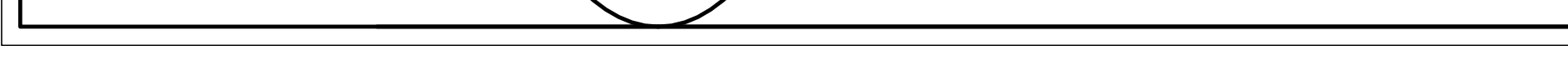

מספר	תאריך	תפוצה
1	14.03.18	
2	20.03.18	
שינוי עדיכון		
מספר	תאריך	